

# CATÁLOGO



# 2026



## HostelNovo

**Hostelnovo del Vallès** es un fabricante y mayorista especializado en menaje y equipamiento para hostelería y colectividades, con **más de 25 años de experiencia** acumulada en el sector.

Diseñamos, fabricamos e importamos soluciones en acero inoxidable, cristal, metacrilato, madera y otros materiales, pensados para mejorar la presentación, la operativa y la rentabilidad de negocios de hostelería.



### PROPUESTA DE VALOR PRINCIPAL

- Catálogo amplio y especializado: suministros y accesorios de hostelería, coctelería y menaje de cocina, todo disponible y orientado al cliente profesional.
- Capacidad de diseño propio y fabricación: muchos productos son desarrollos propios que no se encuentran en otros catálogos, lo que permite a nuestros clientes diferenciarse.
- Personalización: cualquier producto de madera o metacrilato se puede personalizar en tamaño, color y diseño, adaptándolo a la imagen de marca del cliente (logotipos, formatos especiales, etc.).



## BENEFICIOS PARA EL CLIENTE PROFESIONAL

- Diferenciación en sala y en barra: bandejas, soportes, presentaciones de alimentos y accesorios únicos que elevan la percepción de calidad del local y justifican mejor el precio medio.
- Eficiencia operativa: productos pensados desde la experiencia en hostelería, que facilitan el servicio, mejoran la organización de mise en place y reducen tiempos de manipulación.
- Imagen de marca: gracias a la personalización (madera y metacrilato), el cliente puede reforzar su branding en soportes de carta, expositores, etc



## CONDICIONES COMERCIALES Y SERVICIO

- Servicio mayorista flexible: compra, venta, exportación, importación, diseño, fabricación y acabado de mobiliario auxiliar, enseres de hostelería y artículos de menaje y equipamiento del hogar, cubriendo tanto necesidades estándar como proyectos a medida.
- Condiciones de venta competitivas: opciones de transporte bonificadas a partir de ciertos importes de pedido, diferentes medios de pago y una política adaptada a normativa vigente para plazos.
- Atención cercana: trato directo, búsqueda personalizada del producto que el cliente necesita y asesoramiento para encontrar la solución más adecuada a cada tipo de negocio.

# NOVEDADES

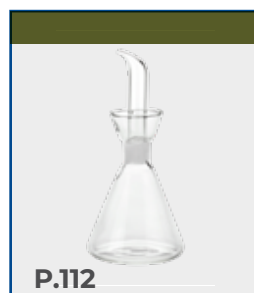
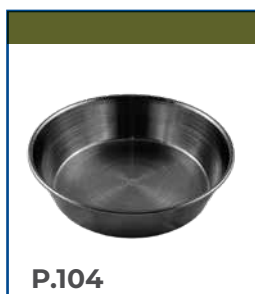
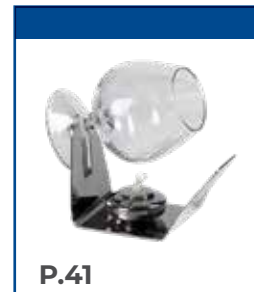

# NOVEDADES

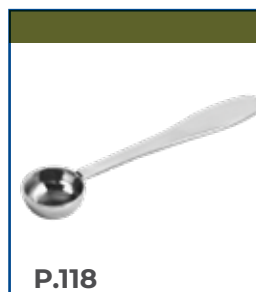

# NOVEDADES

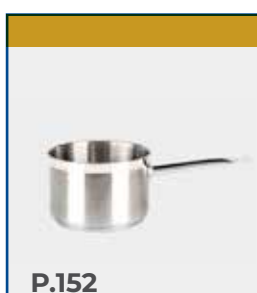
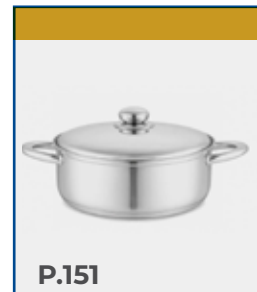
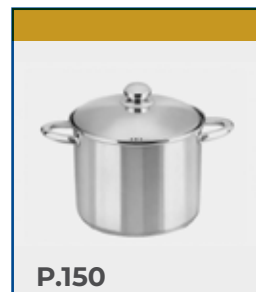
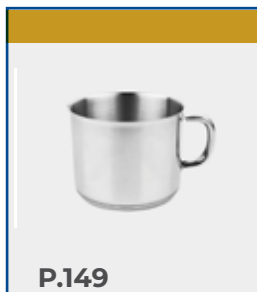
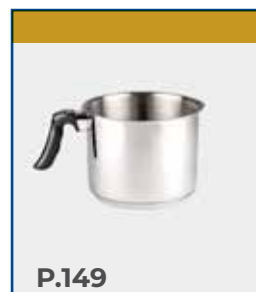
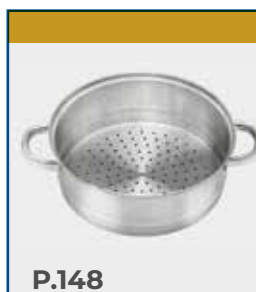
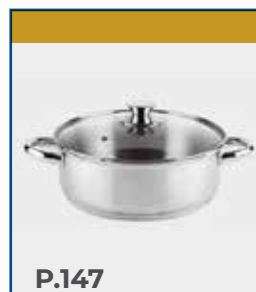

# NOVEDADES

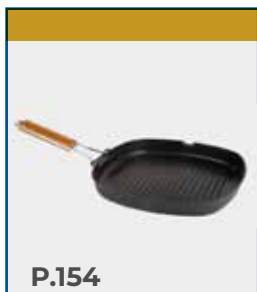

P.154



P.154

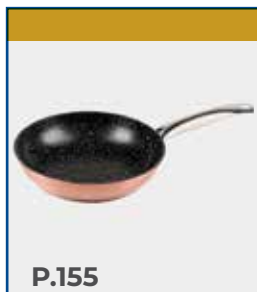

P.155



P.155



P.155

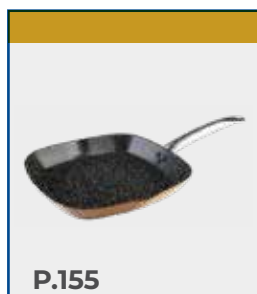

P.155



P.156



P.156



P.156

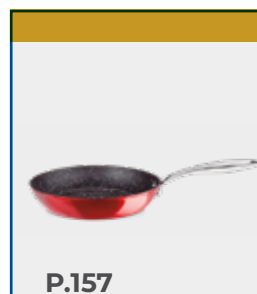

P.157



P.157



P.157

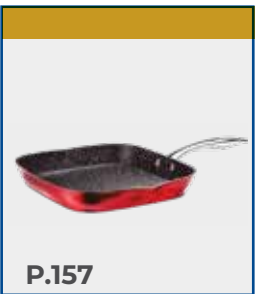

P.157

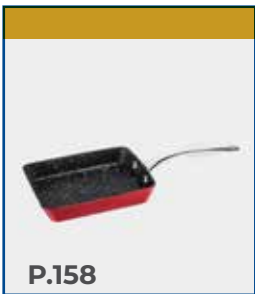

P.158



P.158



P.158



P.158



P.159



P.159



P.159

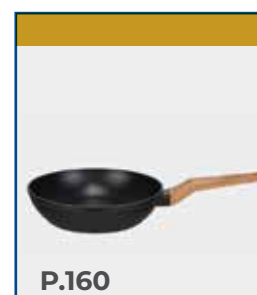

P.160



P.160



P.160

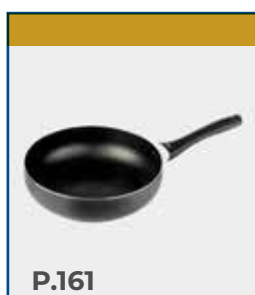

P.161



P.161

# NOVEDADES



P.161



P.162



P.162

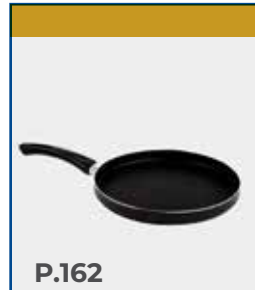

P.162



P.163



P.163

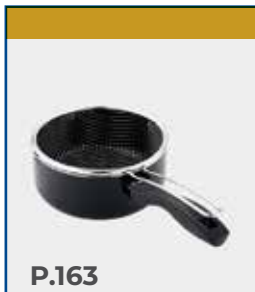

P.163

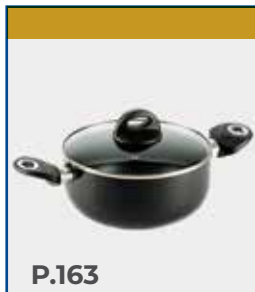

P.163



P.164



P.164

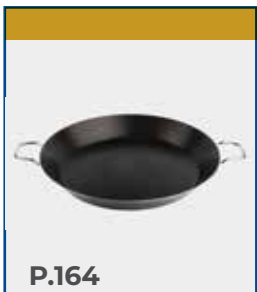

P.164



P.167

# ÍNDICE

COCTELERÍA ..... **10**



MOBILIARIO ..... **46**



PRESENTACIÓN  
DE ALIMENTOS ..... **51**



DESECHABLES... **75**



MUNDO PIZZA .... **81**



BANDEJAS &  
FUENTES ..... **92**



MESA ..... **101**



COCINA ..... **133**

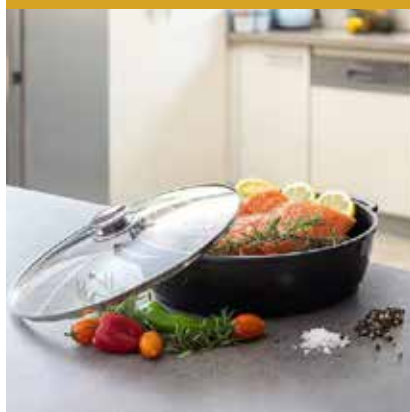

PINZAS ..... **165**





# COCTELERÍA





Colador gusanillo inox s/prongs. Luxe

MEDIDAS (cm)	MATERIAL	REF.
20*9	INOX	60



Colador gusanillo inox s/prongs Premium

MATERIAL	REF.
INOX	61



Colador gusanillo s/ prongs

MEDIDAS (cm)	REF.
19	136



Colador gusanillo 2 prongs. Luxes

MEDIDAS (cm)	REF.
16	CTSN0001



### Colador cóctel profesional

MEDIDAS (cm)	MATERIAL	REF.
Ø 20*9	INOX	164



### Colador gusanillo con 4 prongs

MEDIDAS (cm)	COLOR	REF.
15*8	Cobre	165/1



### Colador de coctel calavera inox

MEDIDAS (cm)	MATERIAL	REF.
18	INOX	CTSN0022-SS

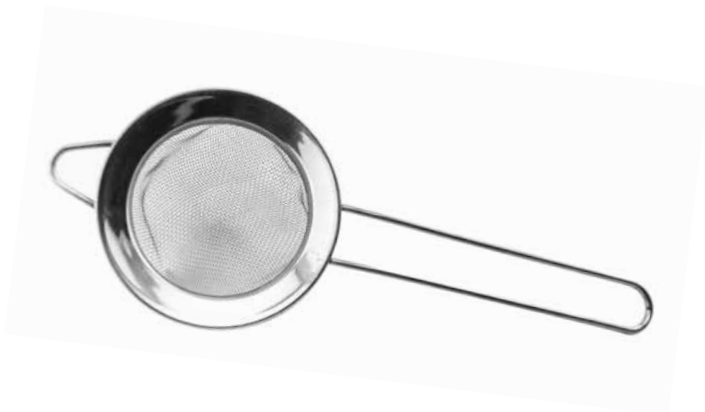

Colador INOX redondo

MEDIDAS (cm)    REF.

Ø 22\*8            613



Colador INOX cónico

MEDIDAS (cm)    REF.

Ø 22\*8            613/1



Julep Strainer sin pestañas

MATERIAL            REF.

Cobre                414

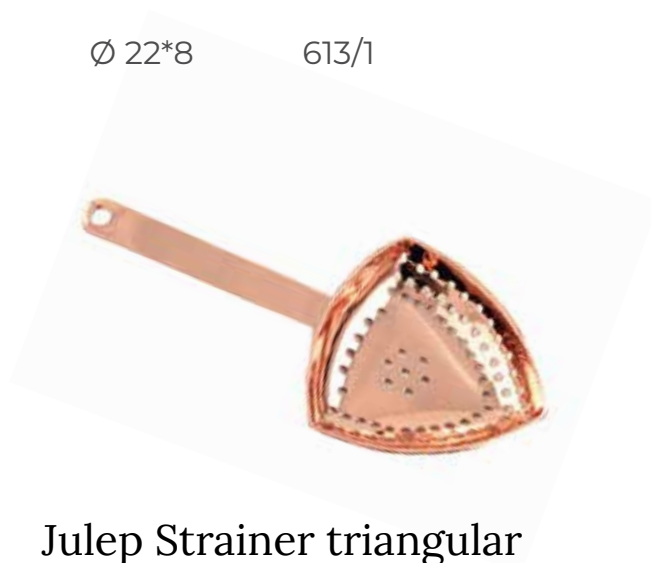

Julep Strainer triangular

MATERIAL            REF.

Cobre                415



Julep strainer sin pestañas

MATERIAL            REF.

INOX                146



Cuchara especial absenta

REF.

152



Moscow mule liso

CAPACIDAD (ml)	REF.
470	946



Moscow mule envejecido

CAPACIDAD (ml)	REF.
470	763



Set de Moscow mule

REF.
997-4



Incluye bandeja, portavasos y 4 pajitas de metal

Moscow mule amartillado



CAPACIDAD (ml)	REF.
470	997

Black Moscow Mule



CAPACIDAD (cl)	MATERIAL	REF.
47	INOX	946-1



Julep cobre

<u>CAPACIDAD (ml)</u>	<u>REF.</u>
475	1002



Jigger japonés

<u>MEDIDAS</u>	<u>REF.</u>
30/60	416



Dosificador licores (Jigger)

<u>MEDIDAS</u>	<u>MATERIAL</u>	<u>REF.</u>
Jigger 2/4	INOX	971
Jigger 3/5	INOX	972



Dosificador de licores Jigger japonés. INOX

<u>MEDIDAS</u>	<u>REF.</u>
25/50	676



Vaso inox coctelera

<u>MEDIDAS (ml)</u>	<u>REF.</u>
250	279
350	280



Julep

<u>CAPACIDAD (ml)</u>	<u>MATERIAL</u>	<u>REF.</u>
470	INOX	947



### Coctelera Boston

<u>CAPACIDAD (cl)</u>	<u>REF.</u>
75	437



### Coctelera de lujo

<u>CAPACIDAD (cl)</u>	<u>REF.</u>
75	426



### Coctelera Boston inclinada con vaso de cristal

<u>CAPACIDAD (cl)</u>	<u>REF.</u>
75	438



### Coctelera europea inox

<u>MEDIDAS (ml)</u>	<u>MATERIAL</u>	<u>REF.</u>
300	INOX	501
550	INOX	698
750	INOX	699



Coctelera amartillada

MEDIDAS (ml)	MATERIAL	REF.
550	INOX	697
750	INOX	696



Coctelera francesa oro

CAPACIDAD (ml)	REF.
600	758



Coctelera Mojito

MEDIDAS (ml)	REF.
585	1052



Coctelera Boston  
2 piezas, con vaso de vidrio

MEDIDAS (ml)	MATERIAL	REF.
800	INOX	700



Coctelera Boston  
Vaso de recambio

MATERIAL	REF.
Cristal	700/1



Cuchara trenzada luxury black

<u>MEDIDAS (cm)</u>	<u>REF.</u>
28,5	418-1



Cuchara espiral japonesa

<u>MEDIDAS (cm)</u>	<u>REF.</u>
40	960-2



Cuchara telescópica

<u>MEDIDAS (mm)</u>	<u>REF.</u>
150-450	420



Cuchara trenzada con pomo de libélula

<u>MEDIDAS (cm)</u>	<u>MATERIAL</u>	<u>REF.</u>
33	INOX	715



Cuchara trenzada con tridente

<u>MEDIDAS (cm)</u>	<u>REF.</u>
25	961



Cuchara molecular

<u>MEDIDAS (cm)</u>	<u>REF.</u>
16	612



Cuchara coctel 4 en 1

<u>MEDIDAS (cm)</u>	<u>REF.</u>
28,5*4	960-4



Cuchara Gin Tonic 3 en 1

<u>REF.</u>
1057



Cuchara coctel multiusos negra  
3 en 1

MEDIDAS (cm)	REF.
30	1047



Cuchara coctel multiusos azul  
3 en 1

MEDIDAS (cm)	REF.
30	1054

Cuchara coctel multiusos roja  
3 en 1

MEDIDAS (cm)	REF.
30	1055

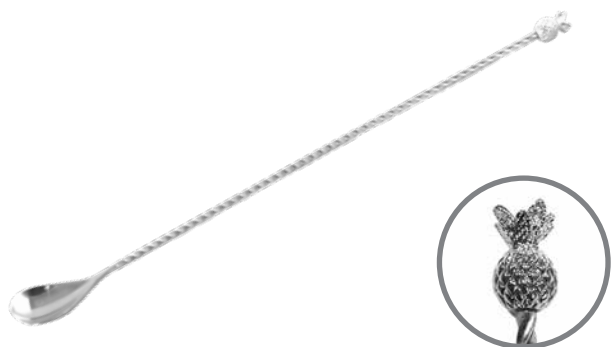
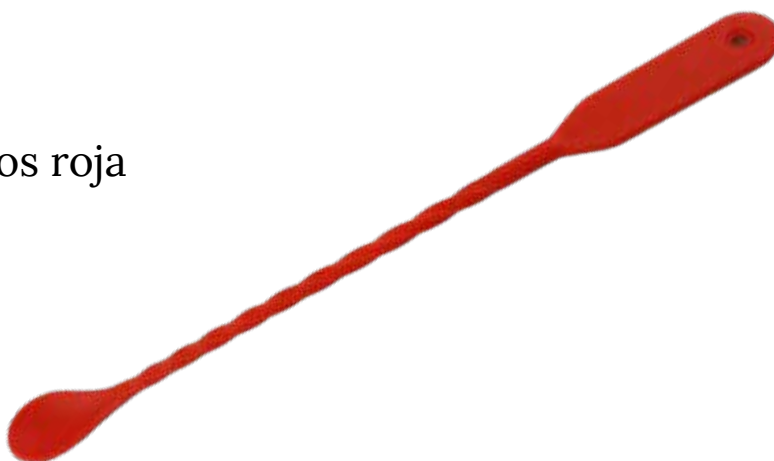

Cuchara trenzada con pomo  
de piña

MEDIDAS (cm)	MATERIAL	REF.
33	INOX	711
43	INOX	713

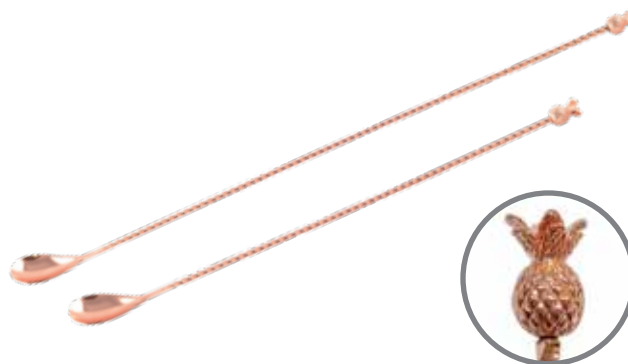

Cuchara trenzada con pomo  
de piña

MEDIDAS (cm)	MATERIAL	REF.
33	Cobre	712
43	Cobre	714



Cuchara trenzada (teardrop)

MEDIDAS (cm)	MATERIAL	REF.
33	INOX	458
45	INOX	459



Cuchara luxury trenzada

MEDIDAS (cm)	REF.
28,5	418



Cuchara Calavera

MEDIDAS (cm)	MATERIAL	REF.
330	Cobre	BRSN0029-CP
330	INOX	BRSN0029-SS



Cuchara trenzada teardrop

MEDIDAS (cm)	MATERIAL	REF.
26	Cobre	419



### Exprimidor para limones

<u>MEDIDAS (cm)</u>	<u>MATERIAL</u>	<u>REF.</u>
6	Aluminio	782310



### Exprimidor para limas

<u>MEDIDAS (cm)</u>	<u>MATERIAL</u>	<u>REF.</u>
5	Aluminio	782410



### Exprimidor madera de haya

<u>NOVEDAD (cm)</u>	<u>REF.</u>
16	747940



### Exprimidor manual

<u>MEDIDAS (cm)</u>	<u>REF.</u>
18	780900



## Exprime limones



**MEDIDAS (cm)**

14

**MATERIAL**

Cristal

**REF.**

1040



## Exprimidor fruta manual

**MEDIDAS (cm)**

17\*9

**MATERIAL**

INOX

**REF.**

210



## Exprimidor limones ECO

**REF.**

762-1



## Exprimidor limones Luxe

**MATERIAL**

INOX

**REF.**

762



Mano mortero linea cintura

MEDIDAS (cm)	MATERIAL	REF.
22,5*4	INOX	708



Mano mortero acanalado

MEDIDAS (cm)	MATERIAL	REF.
Ø 20*2,5	INOX	954



Muddler

MEDIDAS (cm)	MATERIAL	REF.
21	INOX - Plástico	781000



Mano mortero acanalado

MEDIDAS (cm)	COLOR	REF.
22	Blanco	958



Mano mortero acanalado

MEDIDAS (cm)	MATERIAL	REF.
Ø 25*3,5	Polipropileno	952



Mano Mojito

MEDIDAS (cm)	MATERIAL	REF.
27	Madera	64.1



Mano mortero liso

MEDIDAS (cm)	COLOR	MATERIAL	REF.
22	Negro	Polipropileno	955
22	Blanco	Polipropileno	956



Mano mortero acanalado

MEDIDAS (cm)	COLOR	REF.
22	Negro	957



Mano mortero acanalado

MEDIDAS (cm)	MATERIAL	REF.
Ø 25*3,5	Polipropileno	952-1



Banda para barman

COLOR	REF.
Negro	442



Banda plata para barman (2ud.)

MATERIAL	REF.
Metal	442/1



Tapa polvo universal para todos los vertedores

CANTIDAD	REF.
1 Docena	DGP-BLK



Rallador especial coctelería

MEDIDAS (cm)	REF.
14	443



Ribeteador 3 recipientes

MEDIDAS (cm)	MATERIAL	REF.
20*15, 5*7, 5	Polipropileno	950



Cubre polvo para vertedor estrecho

CANTIDAD	REF.
1 Docena	NDC-BLK



### Tapón para contenedor dosificador

CANTIDAD	MATERIAL	REF.
Set de 6 tapones	Polipropileno	977

### Tapón universal transparente y abridor

REF.
1049



### Contenedor dosificador barman. Tapón de color aleatorio.

MEDIDAS (L)	MATERIAL	REF.
0,5	Polipropileno	974
1	Polipropileno	975
2	Polipropileno	976



### Botellas tapón de color.

MEDIDAS (L)	COLOR TAPÓN	REF.
1	Amarillo	8020-Amarillo
1	Blanco	8020-Blanco
1	Marrón	8020-Marrón
1	Naranja	8020-Naranja
1	Rojo	8020-Rojo
1	Verde	8020-Verde
2	Amarillo	8021-Amarillo
2	Blanco	8021-Blanco
2	Marrón	8021-Marrón
2	Naranja	8021-Naranja
2	Rojo	8021-Rojo
2	Verde	8021-Verde



Vaso medidor mini

MEDIDAS (cm)	MATERIAL	REF.
5	Cristal	744800



Vaso medidor de licor regulable

MEDIDAS (cm)	MATERIAL	REF.
11	Plástico	791700



Vaso mezclador

CAPACIDAD (cl)	REF.
58	OCN610



Vaso mezclador

CAPACIDAD (L)	MATERIAL	REF.
1	Cristal	948



Vaso mezclador New York

CAPACIDAD (L)	REF.
0,55	296



Vaso mezclador

CAPACIDAD (cl)	REF.
75	948-1



Botella bitter

CAPACIDAD (ml)

30

REF.

760



Botella bitter

CAPACIDAD (ml)

200

REF.

761



Botella bitter

CAPACIDAD (ml)

300

REF.

761-1



Botella bitter

CAPACIDAD (ml)

90

REF.

DSBT0005



Bandeja escurridora

MEDIDAS (cm)

40\*20\*2,3

MATERIAL

INOX

REF.

610

30\*15\*2,3

INOX

610-1



Soporte para tubo de ensayo

REF.

493



Caja de presentación  
con compartimentos

<u>MEDIDAS (cm)</u>	<u>MATERIAL</u>	<u>REF.</u>
27*17*10	Madera natural	021224



Porta accesorios barman

<u>CANTIDAD</u>	<u>MATERIAL</u>	<u>REF.</u>
5 separadores	Polipropileno	962



Trituradora de hielo manual

<u>MEDIDAS (cm)</u>	<u>REF</u>
15*12*24,5	400



Pica hielos

<u>MEDIDAS (cm)</u>	<u>REF</u>
23	981



Picador de hielo vintage

<u>REF</u>
619



Cubo hielo con tapa y bandeja extraíbles

<u>CAPACIDAD (L)</u>	<u>MATERIAL</u>	<u>REF.</u>
10	Aluminio cepillado	617



Cubo cerveza botellin 6 L

<u>REF</u>
1042



Mini cubo hielo

<u>CAPACIDAD (L)</u>	<u>REF.</u>
1	CM863



Cubo hielo coctelería

<u>CAPACIDAD (L)</u>	<u>REF.</u>
1,5	604



Cuchillo coctelería

<u>MEDIDAS (cm)</u>	<u>REF.</u>
15	942



Cuchillo cortezas limón

<u>MEDIDAS (cm)</u>	<u>REF.</u>
15,2	943

Set tabla de cortar +  
cuchillos coctelería

<u>REF.</u>
CD2690



Tabla de cortar

<u>MEDIDAS (cm)</u>	<u>MATERIAL</u>	<u>REF.</u>
15,3 x 25,5	Polietileno	CD717



Soporte mesa para cubo

<u>CARACT.</u>	<u>MATERIAL</u>	<u>REF.</u>
Desmontable 2 piezas	INOX	217



Champañera plateada con asas

MEDIDAS (cm)	MATERIAL	REF.
21*21	INOX	018499



Cubo cava 2 botellas

MATERIAL	REF.
INOX	188



Champañera amartillada cobre

MEDIDAS (cm)	MATERIAL	REF.
22,2*20	Cobre	44



Recogedor hielo

MATERIAL	REF.
INOX	90



Recogedor perforado

MEDIDAS (cm)	MATERIAL	REF.
19*6	INOX	407



Recogedor hielo

MATERIAL	REF.
INOX	706
PVC	707



### Dispensador condimentos

<u>MEDIDAS</u>	<u>MATERIAL</u>	<u>REF.</u>
6 recipientes	Polipropileno	973



### Dispensador 4 compartimentos

<u>MEDIDAS (cm)</u>	<u>MATERIAL</u>	<u>REF.</u>
62*18,5*16,5	Polipropileno	973-2



### Dispensador condimentos

<u>MEDIDAS</u>	<u>MATERIAL</u>	<u>REF.</u>
6 recipientes	INOX	980



### Estanteria bar plateado 8 botellas

<u>MEDIDAS (cm)</u>	<u>MATERIAL</u>	<u>REF.</u>
82*10*15	INOX	980-1



944



945



945-1



Tapete antideslizante

MEDIDAS (cm)	MATERIAL	REF.
60*8	Antideslizante	944
45,5*30,5	Antideslizante	945
30*15	Antideslizante	945-1



Abridor especial coctelería

MEDIDAS (cm)	REF
18	967



Abridor especial coctelería

MEDIDAS (cm)	REF
11	968



Abridor Escorpión verde

REF
CEBP0028-GRE



Abridor cocktail

MEDIDAS	REF.
178 mm	440



Pinza hielo dentada luxe

<u>MEDIDAS (cm)</u>	<u>REF.</u>
16,5	37-1



Pinza coctel multiusos 3 en 1

<u>COLOR</u>	<u>REF.</u>
Negro	1048

Pajitas papel imitacion bambú

<u>REF.</u>
156-1



Dispensador de canutillos

<u>MEDIDAS (cm)</u>	<u>REF.</u>
21,5*27*9	618



### Posa vasos luminosos.

4 Piezas LED. Colores ON/Off, botón redondo. Impermeables acrílicos. Aptas para botellas de vino, copas, fiestas, bares...

**REF.**  
094



### Copa Cocktail de Coco Natural

**MEDIDAS** (mm)

**REF.**

135\*60

CC000006

### Tiki cráneo de cristal

**CAPACIDAD** (ml)

**REF.**

600

765





Tiki cráneo de cristal

<u>CAPACIDAD (ml)</u>	<u>REF.</u>
100	764



Jarra cerveza calavera

<u>CAPACIDAD (ml)</u>	<u>REF.</u>
350	GW-BRGS0001



Vaso chupito calavera

<u>CAPACIDAD (ml)</u>	<u>REF.</u>
50	764-1



Porta chupito doble para vaso calavera

<u>MATERIAL</u>	<u>REF.</u>
Madera	764-2



2362 VASO NATURAL  
JUICE 550CC

2360 VASO  
ANANAS 700CC

2361 VASO TIKI  
550CC

TIKI0052 VASO VIDRIO  
TIKI KAUPE 440 ML



2348  
VASO FRANKENSTEIN  
500CC

2346  
VASO CALAVERA  
450CC

2347  
VASO CALAVERA  
550CC

2367  
VASO SAC ALTO  
350CC



3100  
TAZA  
H.10 cm Ø 12 cm. 350CC



2368  
Vaso. 350cc.



582  
26 cm.



5862DB19  
26cm.

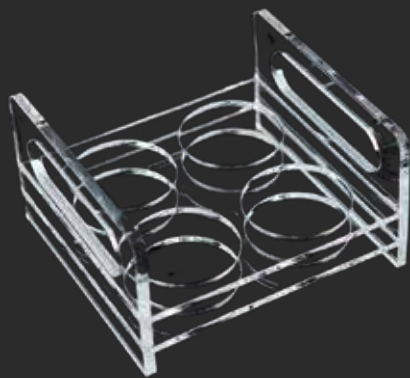

### Rack shot de 2 agujeros

MEDIDAS (cm)	MATERIAL	REF.
8,5*11,5*7	Metacrilato negro	757.3
8,5*11,5*7	Metacrilato	599.3

### Rack shot de 4 agujeros

MEDIDAS (cm)	MATERIAL	REF.
12,5*11,5*7	Metacrilato negro	757
12,5*11,5*7	Metacrilato	757.1



### Rack shot de 6 agujeros

MEDIDAS (cm)	MATERIAL	REF.
18*11,5*7	Metacrilato negro	599
18*11,5*7	Metacrilato	599.1

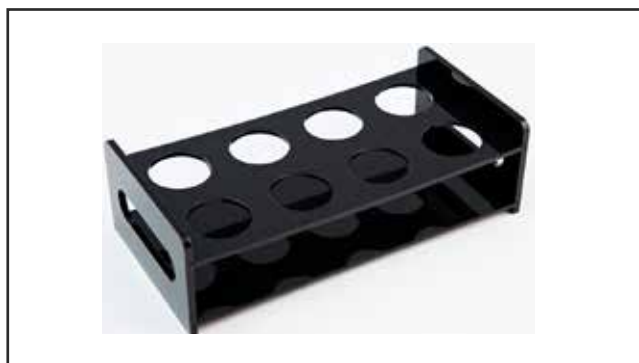
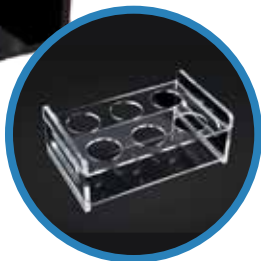

### Rack shot de 8 agujeros

MEDIDAS (cm)	MATERIAL	REF.
23,5*11,5*7	Metacrilato negro	600
34,5*11,5*7	Metacrilato	600.2



### Rack shot de 12 agujeros

MEDIDAS (cm)	MATERIAL	REF.
34,5*11,5*7	Metacrilato negro	601
34,5*11,5*7	Metacrilato	600.1



Calienta copas c/ copa tallada

MEDIDAS (cm)	MATERIAL	REF.
		166



Dosificador cóctel

MEDIDAS (mm)	CAPACIDAD (ml)	REF.
66*82	100	769



Botella atomizador Torre Eiffel con perilla

CAPACIDAD (ml)	REF.
50	SPBT0003



Vaso alto lata refresco

CAPACIDAD (cl)	REF.
47,5	777
47,5	778



Vaso en forma de bombilla

CAPACIDAD (ml)	REF.
150	789
250	790



Vaso bambú

<u>TAMAÑO</u>	<u>REF.</u>
Grande	156-5



Vaso cerámica bambú

<u>CAPACIDAD (ml)</u>	<u>REF.</u>
470	TIKI0003



Vaso ceramica Kane Tiki

<u>CAPACIDAD (ml)</u>	<u>REF.</u>
400	TIKI0038



Vaso Tiki cerámica bambú verde

<u>CAPACIDAD (ml)</u>	<u>REF.</u>
320	TIKI0055



Decantador de calavera negro de lujo pintado a mano

<u>CAPACIDAD (ml)</u>	<u>REF.</u>
700	TIKI0061



Copa Margarita  
cobre

CAPACIDAD (ml)

340

REF.

MUGS0039-CP



Copa Martini

CAPACIDAD (cl)

25

REF.

439



Vaso coctel calabaza cobre

CAPACIDAD (ml)

700

REF.

MUGS0017-CP

Presentación piña bañado en cobre

CAPACIDAD (ml)

900

REF.

1008





### Set de coctel

PIEZAS	MEDIDAS (cm)
--------	--------------

4	33,5*23*11
---	------------

MATERIAL	REF.
----------	------

Madera-Cobre	1000
--------------	------



### Caja con tapa envejecida + tiki vaso calavera + 4 chupitos calavera

MEDIDAS (cm)	REF.
--------------	------

24*19,5*14,5	447
--------------	-----



Set de coctel. 4 piezas

MEDIDAS (cm)	MATERIAL	REF.
33,5*23*11	Madera-INOX	1001/1



Set de coctel con 4 piezas

MEDIDAS (cm)	MATERIAL	REF.
34*23*11	INOX (caja de cartón)	998



Sifón especial coctelería

REF.
615



Recargas CO2

REF.
615-1



# MOBILIARIO





SE HACE CUALQUIER COLOR A MEDIDA

Descansa bandejas

MEDIDAS (cm)	COLOR	REF.
40*37*82	Blanco	569
40*37*82	Wengue	581
40*37*82	Natural	581-1
40*37*82	Nogal	584
40*37*82	Caoba	585
40*37*82	Negro	585-1



Carro madera auxiliar Gueridón

MEDIDAS (cm)	COLOR	REF.
74*48*75	Nogal	359
74*48*75	Wengé	359/2



Mini soporte tijera mesa

<u>MEDIDAS (cm)</u>	<u>REF.</u>
24	233



Soporte para bandejas

<u>MEDIDAS (cm)</u>	<u>MATERIAL</u>	<u>REF.</u>
47,5*39*72	INOX	593



Soporte cuelga copas INOX  
Universal pared/techo

Timbre hotel

<u>MEDIDAS (cm)</u>	<u>CAPACIDAD</u>	<u>REF.</u>
44*32	20 copas	821

<u>REF.</u>
256



**NOVEDAD Y MODELO EXCLUSIVO  
HOSTELNOVO POR LLEVAR UNA BANDEJA  
INCORPORADA + LA POSIBILIDAD DE  
PONER OTRA BANDEJA**

Descansa bandejas nogal  
c/ bandeja incorporada

<u>MEDIDAS (mm)</u>	<u>MATERIAL</u>	<u>REF.</u>
580*400*840	Nogal	EH7230D





# PRESENTACIÓN DE ALIMENTOS





Set olla+ vaporera bambú

MATERIAL	REF.
Bambú- Tapa cristal	663822

018305



018307

Base vaporera de bambú

MEDIDAS (cm)	REF.
20*6	018305

Tapa vaporera de bambú

MEDIDAS (cm)	REF.
20*3	018307



Recipiente comida al vapor

MEDIDAS (cm)	REF.
15*8	813



Vaporera de bambú

MEDIDAS (cm)	REF.
8*6	CM016561



Vaporera

MEDIDAS (cm)	COLOR	MATERIAL	REF.
30	Natural	Bambú	14



### Plato Volcán Kilimanjaro

MEDIDAS (cm)	COLOR	MATERIAL	REF.
22	Blanco	Cerámica	727

### Plato Volcán Cerro Negro

MEDIDAS (cm)	COLOR	MATERIAL	REF.
22	Negro	Cerámica	728

### Plato Aroa

MEDIDAS (cm)	COLOR	MATERIAL	REF.
13*13	Negro	Cerámica	725
22*22	Negro	Cerámica	725/ 2



### Plato pulpo madera

MEDIDAS (cm)	MATERIAL	REF.
18	Madera	910
24	Madera	911
30	Madera	912



### Cuenco de Coco Natural

MEDIDAS	REF.
135*60 mm	CC000001



Baldosa hidráulica

MEDIDAS (cm)	COLOR	REF.
30*15*1	azul	1006-20



Baldosa hidráulica

MEDIDAS (cm)	COLOR	REF.
30*15*1	roja	1006-21



Baldosa hidráulica

MEDIDAS (cm)	COLOR	REF.
30*15*1	marrón	1006-22



Baldosa hidráulica

MEDIDAS (cm)	COLOR	REF.
30*15*1	gris	1006-23



Baldosa hidráulica

MEDIDAS (cm)	COLOR	REF.
15*17*1	azul	1006-30



Baldosa hidráulica

MEDIDAS (cm)	COLOR	REF.
15*17*1	roja	1006-31

Baldosa hidráulica

MEDIDAS (cm)	COLOR	REF.
15*17*1	marrón	1006-32



Baldosa hidráulica

MEDIDAS (cm)	COLOR	REF.
15*17*1	gris	1006-33

Baldosa hidráulica s/ soporte

MEDIDAS (cm)	REF.
33*16,5	1006-1



Tejas árabes

MEDIDAS (cm)	REF.
30	257
25	258



Teja esmaltada manual  
c/ esmalte alimentario

MEDIDAS (cm)	COLOR	REF.
30*9	Marrón	298
30*9	Negro	298-1



Teja especial calçots  
c/ esmalte alimentario

MEDIDAS (cm)	COLOR	REF.
30*11	Marrón	1298
30*11	Negra	1298-1



Set calçots

CARACTERÍSTICAS	REF.
2 tejas, salsera, 2 sets desechables	768



4 sets desechables calçots

CARACTERÍSTICAS	REF.
1 babero, 2 guantes 1 toallita de limón, 1 toallita de papel	768-1



### Caja buffet medidas gastronom



<u>MEDIDAS (cm)</u>	<u>MATERIAL</u>	<u>REF.</u>
53*32,5*10	Madera	264
32,5*26,5*10	Madera	265
32,5*17,5*10	Madera	266
26,5*17,5*10	Madera	267
53*17,5*10	Madera	268



### Caja mini

<u>MEDIDAS (cm)</u>	<u>MATERIAL</u>	<u>REF.</u>
21*16*8	Calabó	862



### Caja cubiertos

<u>MEDIDAS (cm)</u>	<u>REF.</u>
29*19*7	897



### Caja mini

<u>MEDIDAS (cm)</u>	<u>REF.</u>
14*14*6,5	898



Caja mini frutas c/ 2 lamas

<u>MEDIDAS (cm)</u>	<u>REF.</u>
20,5*13*6,5	899



Caja mini con malla

<u>MEDIDAS (cm)</u>	<u>REF.</u>
20*3*6,5	739
25*17*10	744



Caja de madera natural multiusos

<u>MEDIDAS (cm)</u>	<u>COLOR</u>	<u>MATERIAL</u>	<u>REF.</u>
20*16*8	Wengue	Madera	55



Caja de madera natural multiusos

<u>MEDIDAS (cm)</u>	<u>COLOR</u>	<u>MATERIAL</u>	<u>REF.</u>
27*27*10	Negro	Madera	59

Panera bambú

<u>MEDIDAS (cm)</u>	<u>COLOR</u>	<u>REF.</u>
20*15*9	Bambú	928





Mini cajita  
presentación madera

MEDIDAS (cm)	COLOR	REF.
30*21*7	Marrón	246
30*21*7	Natural	246-1



Caja mini

MEDIDAS (cm)	MATERIAL	REF.
30*24*10	Calabó	863

Caja mini

MEDIDAS (cm)	REF
25*17*10	925





### Caja madera

MEDIDAS (cm)	COLOR	REF.
40*30*12,5	Negro	740
40*30*12,5	Haya	741
40*30*12	Wengue	742

### Caja panera (con tela)

MEDIDAS (cm)	REF.
20,5*13*6,5	878



### Caja mini multiusos

MEDIDAS (cm)	REF.
20,5*13*6,5	917



### Caja calabó

MEDIDAS (cm)	REF.
29*19*7	990



732



731



994

### Caja mini multiusos

MEDIDAS (cm)	COLOR	REF.
20,5*13*6,5	Wengue	731
20,5*13*6,5	Nogal	732
20,5*13*6,5	Haya	994

### Caja mini multiusos

MEDIDAS (cm)	CARACT.	REF.
20,5*13*6,5	Blanco Envejecido	743





### Caja multiusos envejecida

MEDIDAS (cm)	CARACT.	REF.
17*12*9	Wengue	674-1
25*17*10	Wengue	675-1
17*12*9	Madera	674-2
25*17*10	Madera	675-2

### Caja mini envejecida

MEDIDAS (cm)	REF
20,5*13*6,5	917-3



### Caja multiusos envejecida

MEDIDAS (cm)	REF
25*17*10	925-2



Tabla corte presentación curados

<u>MEDIDAS (cm)</u>	<u>REF.</u>
35*18*1,5	913



Tabla presentación olivo

<u>MEDIDAS (cm)</u>	<u>REF.</u>
35	241
40	242
30	243



Tabla presentacion olivo c/ mango

<u>MEDIDAS (cm)</u>	<u>REF.</u>
35*17	241/1



Tabla de madera de acacia

<u>MEDIDAS (cm)</u>	<u>REF.</u>
42*19*2	244
36*25*2	245



Tabla corte presentación quesos

<u>MEDIDAS (cm)</u>	<u>REF.</u>
30	914



### Micro palet

MEDIDAS (cm)	COLOR	REF.
12*8*2,2	Natural	921
12*8*2,2	Envejecido	921-1



### Mini palet

MEDIDAS (cm)	COLOR	REF.
20*12*2,4	Natural	915
20*12*2,4	Envejecido	915-1
30*20*2,4	Natural	916
30*20*2,4	Envejecido	916-1
40*15*2,4	Natural	918
40*15*2,4	Envejecido	918-1



### Pala rectangular de bambú

MEDIDAS (cm)	REF.
42*24*1,7	022367



Pata jamonera

MEDIDAS (cm)	REF.
40*15	294/1



Expositor de embutidos

MEDIDAS (cm)	REF.
20*15*40	702.1



Colgador 3 brochetas

REF.
628500



Set de 6 brochetas planas

REF.
628600



Soporte de madera para tacos

REF.
1016



Bowls

MEDIDAS (cm)	COLOR	REF.
Ø 11*4,5	Bambú	933
Ø 17*6	Bambú	325



Barca pescado

MEDIDAS (cm)	REF.
44*31*11	936



Estera para sushi bambú natural

MEDIDAS (cm)	REF.
24*24	022471



Estera presentación bambú natural

MEDIDAS (cm)	REF.
26,5*16,2	023372



Estera presentación bambú natural

MEDIDAS (cm)	REF.
32,5*26,5	023373

Bases sushi

MEDIDAS (cm)	COLOR	REF.
30*11*2,5	Natural	929
30*11*2,5	Negro	930





Cono chips

REF.

925



Cesto rectangular

MEDIDAS (cm)

25\*10

REF.

634

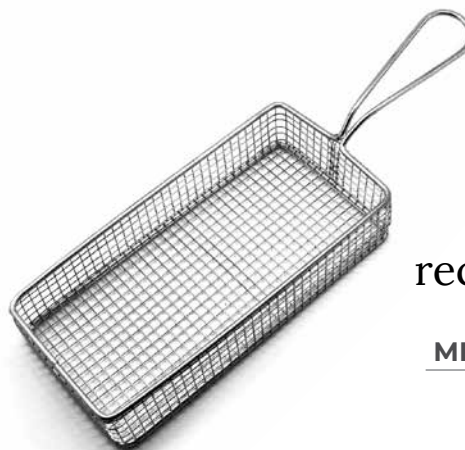

Cesto cuadrado

MEDIDAS (cm)

10\*9

REF.

632

13\*11

633



Cesto redondo

MEDIDAS (cm)

8

REF.

635

9

636



Cesta alambre NBA

MEDIDAS (cm)

9\*7\*10

REF.

150



Huevera forma copa

MATERIAL

Acero

REF.

115





### Cubo presentación galvanizado



<u>MEDIDAS (cm)</u>	<u>REF.</u>
7*5*5,5	170
9*7,7*10,2	171
11*9,1*11,6	172

### Minicubiteras



<u>MEDIDAS (cm)</u>	<u>REF.</u>
12	638



### Cubo Ovalado Galvanizado

<u>MEDIDAS (cm)</u>	<u>REF.</u>
23*15,5*7,7	68



### Mini cubeta rectangular

<u>MEDIDAS (cm)</u>	<u>COLOR</u>	<u>REF.</u>
14,5*9,5*4,5	INOX	640
14,5*9,5*4,5	Negro	639



### Mini lechera 60 cl.

<u>MEDIDAS (cm)</u>	<u>REF.</u>
7,5*12	642



### Soporte expositor fuente pescado

<u>MEDIDAS (cm)</u>	<u>REF.</u>
78	276



Bandeja c/asas esmaltada especial arroces

MEDIDAS (cm)	REF.
26*30*1,5	00591/4
32*42	060532

Bandeja de arroz esmaltada

MEDIDAS (cm)	REF.
17*21	586/3
18*18	587/2



Bandeja con asa para arroz

MEDIDAS (cm)	REF.
17*21	590
18*18	591
13*13	592



Bandeja con asas inox especial para servir arroces

MEDIDAS (cm)	MATERIAL	REF.
27*19,5*1,5	INOX	591/1

Bandeja de madera wengue “especial arroces”

MEDIDAS (cm)	COLOR	REF.
27*19,5*1,5	Wengue	591/3



574



574/1

### Soporte de madera caoba

MEDIDAS (cm)	MATERIAL	REF.
17*21	Caoba	574
18*18	Caoba	574/1



### Soporte de madera para mini raciones

MEDIDAS (cm)	MATERIAL	REF.
13*13	Madera	592/1

### Bandeja de madera s/a

MEDIDAS (cm)	MATERIAL	REF.
40*40*5	Pino	832/2

### Base para cúpula

MEDIDAS (cm)	MATERIAL	REF.
33*13	Acacia	015676





Caja para buffet

<u>MEDIDAS (cm)</u>	<u>MATERIAL</u>	<u>REF.</u>
8*8*5*	Bambú	022385



Caja para buffet

<u>MEDIDAS (cm)</u>	<u>MATERIAL</u>	<u>REF.</u>
8*15*5*	Bambú	022386



Caja para buffet

<u>MEDIDAS (cm)</u>	<u>MATERIAL</u>	<u>REF.</u>
15,5*5*31	Bambú	022389



Caja para buffet

<u>MEDIDAS (cm)</u>	<u>MATERIAL</u>	<u>REF.</u>
15,5*15,5*5	Bambú	022387



Caja para buffet

<u>MEDIDAS (cm)</u>	<u>MATERIAL</u>	<u>REF.</u>
15,5*23*5	Bambú	022388



Bandeja Presentación

MEDIDAS	REF.
6 huecos	25
12 huecos	26



Doble "aligador"

MEDIDAS (cm)	COLOR	REF.
15,5*1	Plateado	17



Soporte tacos / burrito REF.  
155

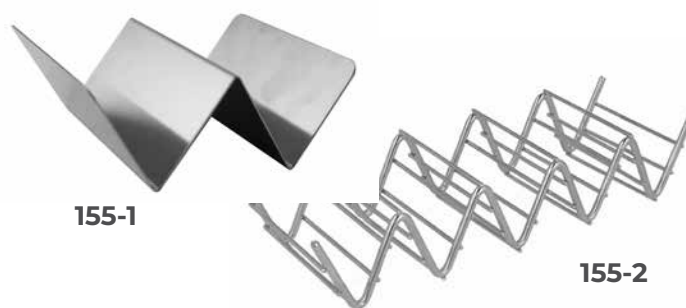

Soporte tacos / burrito REF.  
155-1  
155-2



Soporte taco burrito+ cuenco

MEDIDAS (cm)	REF.
27*10	385

Soporte tacos / burrito

MEDIDAS (mm)	CAPACIDAD (tacos)	REF.
165*80*35	2-3	155-4
205*80*35	3-4	155-5
255*80*35	4-5	155-6

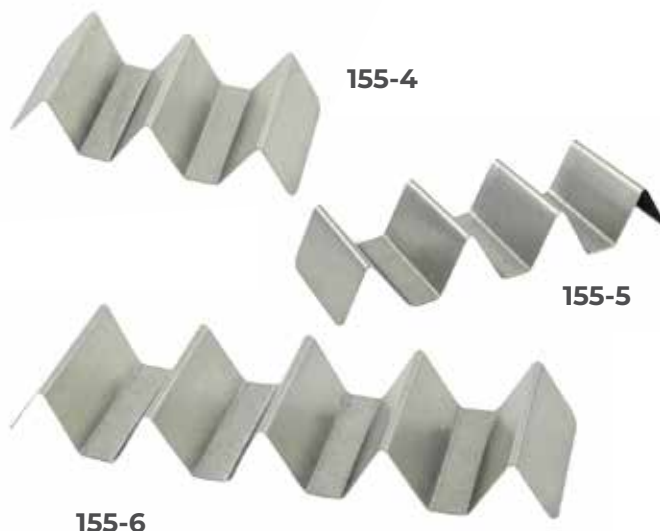



Mini cuenco

MEDIDAS (cm)	MATERIAL	REF.
15*6,5	Cobre/INOX	160



Mini cuenco

MEDIDAS (cm)	MATERIAL	REF.
18*18	Cobre/INOX	158



Mini bowl con asas

MEDIDAS (cm)	MATERIAL	REF.
15*15	Cobre/INOX	157



Mini Bowl c/ asas inox karahi

MEDIDAS (cm)	REF.
16*5	157/1



Expositor campana basculante

MEDIDAS (cm)	REF.
30	285



Expositor tartas

MEDIDAS (cm)	MATERIAL	REF.
30	INOX	311



Lata caracoles

MEDIDAS (cm)	MATERIAL	REF.
17*21	Hierro fundido	586
18*18	Hierro fundido	587



Cazuela para mejillones

CAPACIDAD (Kg)	REF.
1	1010
1,5	1011



Cazuela para mejillones

MEDIDA (cm)	COLOR	REF.
18	Turquesa	914618T
18	Petrol	914618P



Piedra para asar con soporte de madera

MEDIDAS (cm)	REF.
36,5*24	859

Piedra para asar Vitro

MEDIDAS (cm)	REF.
36,5*24	859-1



## Peana de donuts bar con 4 varillas montadas

MEDIDAS	REF
350*100*30 mm Diámetro:15*28,5 cm Base: 31 cm	112

## Quesera apilable



MEDIDAS (cm)	COLOR	REF.
30	Madera	284
30	INOX	284-1

## Peneira

MEDIDAS (cm)	REF.
Ø 15	780
Ø 18	781
Ø 32	782





# DESECHABLES





Papel antigrasa “Parole”

MEDIDAS (cm)	REF.
32*20	003/4



Papel antigrasa “Parole azul”

MEDIDAS (cm)	REF.
32*20	003/5

Papel antigrasa Kraft natural

MEDIDAS (cm)	REF.
32*20	003/6



Papel antigrasa “Parole naranja”

MEDIDAS (cm)	REF.
32*20	003/7



Papel periodico antigrasa  
diseño exclusivo “Leyendas del  
ajedrez (500 ud.)

<u>MEDIDAS (cm)</u>	<u>COLOR</u>
31*28	Blanco
<u>MATERIAL</u>	<u>REF.</u>
Papel reciclado	003/2



Mantelin kraft “Leyendas  
del ajedrez” (500 ud.)

<u>MEDIDAS (cm)</u>	<u>COLOR</u>	<u>MATERIAL</u>	<u>REF.</u>
40*30	Papel Kraft	Papel reciclado	317



Papel kraft antigrasa diseño  
exclusivo “Leyendas del ajedrez”  
(500 ud.)

<u>MEDIDAS (cm)</u>	<u>COLOR</u>	<u>REF.</u>
31*28	Papel Kraft	3



Bolsas abiertas por ambos lados periódico. Especiales para envolver hamburguesas y kebabs (250 ud.)

<u>MEDIDAS (cm)</u>	<u>COLOR</u>
13*14	Diseño periódico
17*18	Diseño periódico
<u>MATERIAL</u>	<u>REF.</u>
Papel	32
Papel	0032/1

Bolsas abiertas por ambos lados Kraft. Especiales para envolver hamburguesas y kebabs (250 ud.)

<u>MEDIDAS (cm)</u>	<u>COLOR</u>	<u>MATERIAL</u>	<u>REF.</u>
13*14	Papel Kraft	Papel Kraft	33
17*18	Papel Kraft	Papel Kraft	0033/1



Bolsas abiertas por ambos lados Kraft. Especiales para envolver creps y tacos (250 ud.)

<u>MEDIDAS (cm)</u>	<u>COLOR</u>	<u>MATERIAL</u>	<u>REF.</u>
13*14	Papel Kraft	Papel Kraft	576



Papel basket chip

CANTIDAD (u)	REF.
500	35



Papel kraft basket "times"

MEDIDAS (cm)	CANTIDAD (u)	REF.
32*20	500	315



Mantelín gaceta

MEDIDAS (cm)	CANTIDAD (u)	REF.
31*43	500	316



Mantelín periódico

MEDIDAS (cm)	CANTIDAD (u)	REF.
31*43	500	319



Mantelín azulejo hidráulico

MEDIDAS (cm)	CANTIDAD (u)	REF.
31*43	500	318



Papel para basket times periódico (500 ud.)

MEDIDAS (cm)	COLOR	MATERIAL	REF.
25*20	Diseño periódico	Papel	40



Cucuruchos para patatas fritas “Times” (pack 50 ud)

<u>MEDIDAS (cm)</u>	<u>COLOR</u>
12,5*22	Blanco
<u>MATERIAL</u>	<u>REF.</u>
Cartoncillo	577



Cucuruchos para patatas fritas “Times” (pack 50 ud)

<u>MEDIDAS (cm)</u>	<u>COLOR</u>
16*27	Blanco
<u>MATERIAL</u>	<u>REF.</u>
Cartoncillo	578



# MUNDO PIZZA





Cortador de pizza Ø 10,5x24 cm

Espolvoreador con asa para sal 450 ml

MEDIDAS (cm)	MATERIAL	REF.
Ø 10,5*24	Inox	248911

MEDIDAS (cm)	COLOR	MATERIAL	REF.
Ø 7*13,2	Plateado	Inox	281422



Espolvoreador con asa para especias 295ml

Espolvoreador de parmesano

MEDIDAS (cm)	COLOR	MATERIAL	REF.
Ø 7*11	Plateado	Inox	281433

MEDIDAS (cm)	MATERIAL	REF.
7,5*14	Cristal	125



Cuchillo de pizza dos manos

MEDIDAS (cm)	MATERIAL	REF.
53*11	Inox	248644



Perforador con púas metálicas para pasta & pizza

MEDIDAS (cm)	COLOR	MATERIAL	REF.
Ø 15,5*21	Blanco	Inox	248766



Perforador antiburbujas para pasta & pizza. 99cm altura

MEDIDAS (cm)	COLOR	MATERIAL	REF.
99	Natural	Madera	24866



Espátula / raspador para masa de pizza

MEDIDAS (cm)	COLOR	MATERIAL	REF.
11*15,2	Plateado	Inox	550811

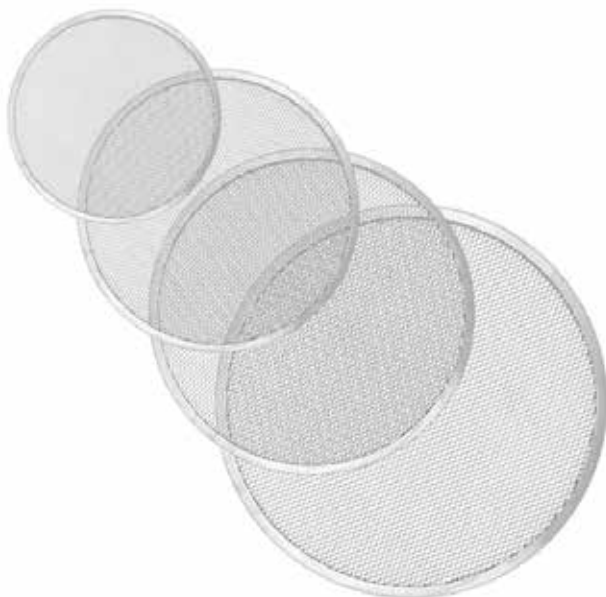

Aro enrejado para pizza

MEDIDAS (cm)	COLOR	MATERIAL	REF.
Ø 25	Plateado	Aluminio	248777
Ø 30	Plateado	Aluminio	248799
Ø 40,6	Plateado	Aluminio	248666
Ø 45,7	Plateado	Aluminio	248677



### Plato llano para pizza

MEDIDAS (cm)	COLOR	MATERIAL	REF.
Ø 28	Plateado	Aluminio	247877
Ø 33	Plateado	Aluminio	247899
Ø 35	Plateado	Aluminio	247900
Ø 40,5	Plateado	Aluminio	247911

### Contenedor apilable para masa de pizza. 15 L

MEDIDAS (cm)	COLOR	REF.
60*40*9	Blanco	283422



### Rack para aros enrejados de pizza

MEDIDAS (cm)	COLOR	MATERIAL	REF.
37*22*25	Plateado	Hierro	248811

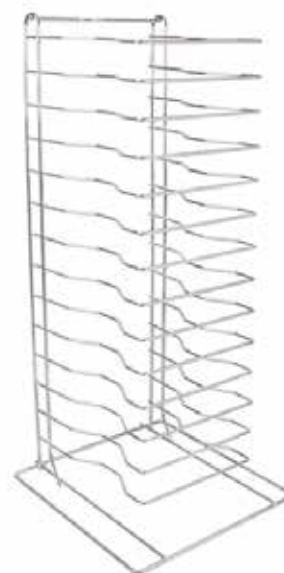

### Rack para pizza 15 niveles

MEDIDAS (cm)	MATERIAL	REF.
30,4*30,4*68	Metal	24899



Rack para colgar palas de pizza

MEDIDAS (cm)	COLOR	MATERIAL	REF.
12*4,5*9,3	Plateado	Acero	2488



Pala de pizza con palo de madera y cantos afilados

MEDIDAS (cm)	MATERIAL	REF.
40,6*45,7*100	Aluminio y madera	248955



Pala de madera para pizza

MEDIDAS (cm)	COLOR	MATERIAL	REF.
36*41*107	Natural	Madera	28155



Pala de pizza tamaño mini

MEDIDAS (cm)	COLOR	MATERIAL	REF.
17,1*19,7*52,1	Plateado	Aluminio	264655



251



251/1

### Pala pizza

MEDIDAS (cm)	MATERIAL	REF.
30	Madera	251
33	Madera	251/1



### Pala horno presentación pizza

MEDIDAS (cm)	MATERIAL	REF.
30*28	Madera	909



### Pala pizza

MEDIDAS (cm)	MATERIAL	REF.
29*2,5	Bambú	931
35*2,5	Bambú	932



Bolsa de 41 cm para transporte de pizza

MEDIDAS (cm)	COLOR	MATERIAL	REF.
43*45*13	Rojo	Vinilo	248366

Bolsa de 46 cm para transporte de pizza

MEDIDAS (cm)	COLOR	MATERIAL	REF.
49*48*13	Rojo	Vinilo	248988



Maleta transporte 6 cajas pizza

MEDIDAS (cm)	COLOR	MATERIAL	REF.
40*34*25,5	Rojo	Vinilo	264711
52*48*33,5	Rojo	Vinilo	264722



Mochila térmica impermeable para transporte de alimentos

MEDIDAS (cm)	COLOR	MATERIAL	REF.
44*37*29	Negro	Vinilo	350666



Bolsa transporte de catering

MEDIDAS (cm)	COLOR	REF.
53,3*35,5*33	Negro	309955



Cajas de pizza microcanal ecológicas 350 gr. (100 uds)

MEDIDAS (cm)	COLOR	MATERIAL	REF.
26*26*3,5	Natural	Cartón	248199
29*29*3,5	Natural	Cartón	248211
40*40*3,5	Natural	Cartón	319744



Bolsas sos para cajas pizza. (100 uds)

MEDIDAS (cm)	COLOR	REF.
37*33*32	Natural Kraf	635122



### Cajas octogonales "The pack" 330 gr. (100 uds)

MEDIDAS (cm)	COLOR	MATERIAL	REF.
26*26*3,8	Natural	Cartón	335444
26*26*3,8	Blanco	Cartón	334433
29*29*3,8	Natural	Cartón	335466
29*29*3,8	Blanco	Cartón	335455
32*32*3,8	Natural	Cartón	335488
32*32*3,8	Blanco	Cartón	335477

### Cajas de cartón para pasta 348 g/m<sup>2</sup> (50 unid.)

MEDIDAS (cm)	COLOR	MATERIAL	REF.
40*30*8	Blanco	Cartón	269266



### Mesitas para el centro de la pizza (2000 ud)

MEDIDAS (cm)	COLOR	MATERIAL	REF.
Ø 4,5*3	Blanco	PP	248466



Platos redondos pizza. (200 uds)

<u>MEDIDAS (cm)</u>	<u>COLOR</u>	<u>MATERIAL</u>	<u>REF.</u>
Ø 33	Blanco	Cartón	269188



Platos triangulares pizza 1/8 (1000 uds)

<u>MEDIDAS (cm)</u>	<u>COLOR</u>	<u>MATERIAL</u>	<u>REF.</u>
24*18	Blanco	Cartón	269255



Platos triangulares pizza 1/4 (500 uds)

<u>MEDIDAS (cm)</u>	<u>COLOR</u>	<u>MATERIAL</u>	<u>REF.</u>
30*21	Blanco	Cartón	26922



Pilla pizza 'The Pack' cartón ondulado nano-micro (1600 uds).

<u>MEDIDAS (cm)</u>	<u>MATERIAL</u>	<u>REF.</u>
12*15,4*2,7	Cartón	334722



Palas pizza triangulares 'The Pack' cartón ondulado nano-micro. (1200 uds.)

<u>MEDIDAS (cm)</u>	<u>MATERIAL</u>	<u>REF.</u>
21*16,5*3,5	Cartón	334744

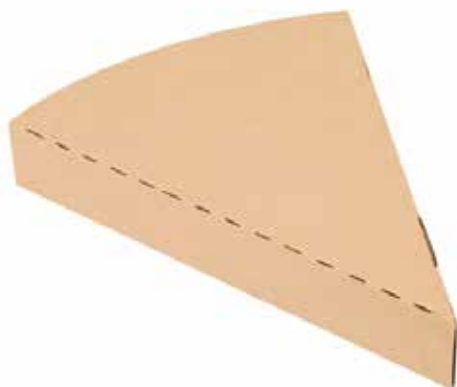

Envases pizza triangulares 'The Pack' cartón ondulado nano-micro. (500 uds.)

<u>MEDIDAS (cm)</u>	<u>MATERIAL</u>	<u>REF.</u>
18*23*3	Cartón	334766



Hojas pergamino antigrasa 34 g/m2. (500 uds)

<u>MEDIDAS (cm)</u>	<u>COLOR</u>	<u>MATERIAL</u>	<u>REF.</u>
31*32	Blanco	Pergamino	248155
31*32	Marrón	Pergamino	333544
35*35	Blanco	Pergamino	333522
35*35	Marrón	Pergamino	333555





# BANDEJAS & FUENTES





**Bandejas apilables con asas**



<u>MEDIDAS (cm)</u>	<u>REF.</u>
46*33*5	907



<u>MEDIDAS (cm)</u>	<u>REF.</u>
33*26*5	908



<u>MEDIDAS (mm)</u>	<u>COLOR</u>	<u>REF.</u>
535*395*45	Wengue	823



<u>MEDIDAS (mm)</u>	<u>COLOR</u>	<u>REF.</u>
615*455*55	Wengue	828



<u>MEDIDAS (mm)</u>	<u>COLOR</u>	<u>REF.</u>
400*400*51	Blanco	831



<u>MEDIDAS (mm)</u>	<u>COLOR</u>	<u>REF.</u>
400*400*51	Wengue	832



MEDIDAS (cm)	COLOR	REF.
42*27*4	Wengue	868



Bandeja con estampado Papel Kraf

MEDIDAS (cm)	REF.
45*36*7	907-1



Bandeja con estampado Base Hidráulica

MEDIDAS (cm)	REF.
45*36*7	907-3

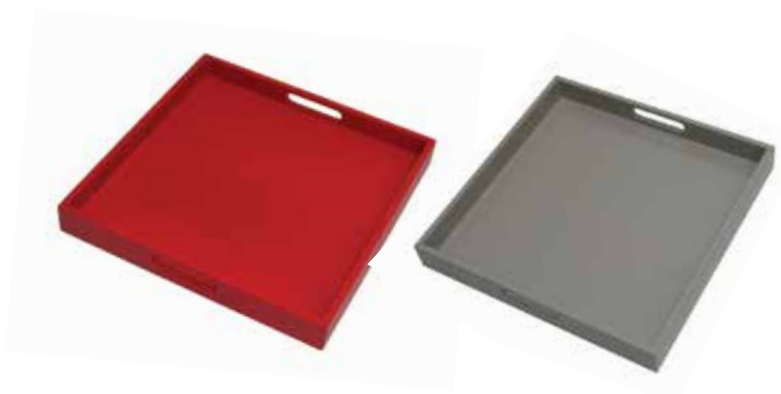

MEDIDAS (cm)	COLOR	REF.
40*40*5,1	Roja	992
40*40*5,1	Gris	993



**Bandejas apilables sin asas**



MEDIDAS (mm)	COLOR	REF.
290*290*45	Wengue	824
260*180*25	Wengue	825



MEDIDAS (mm)	COLOR	REF.
400*230*20	Wengue fondo rojo	826



MEDIDAS (mm)	COLOR	REF.
260*260*15	Wengue	838
400*400*15	Wengue	842
230*230*30	Wengue	843



MEDIDAS (mm)	COLOR	REF.
300*400*15	Blanco	836
400*400*15	Blanco	840



MEDIDAS (mm)	COLOR	REF.
540*165*40	Negro	844
480*450*20	Negro	845



### Cubos multiusos apilable sin asas



#### Bandeja color haya fondo rojo

MEDIDAS (mm)	REF.
400*400*51	989

MEDIDAS (mm)	COLOR	REF.
105*105*60	Blanco	837
105*105*60	Wengue	798



#### Bandeja tarjetera c/tapa

MEDIDAS (cm)	COLOR	REF.
20*13*2,3	Wengue	767



#### Bandeja c/compartimentos

MEDIDAS (cm)	COLOR	REF.
32*23	Blanco	88



Bandeja room service

MEDIDAS (cm)	REF.
60*40*30	804



766-2

Bandeja con compartimentos

MEDIDAS (cm)	COLOR	REF.
31*31*4,5	Miel	766
31*31*4,5	Blanca	766-1
31*31*4,5	Wengue	766-2



Bandeja room service

MEDIDAS (cm)	COLOR	REF.
55*32*4,5	Madera	672
55*32*4,5	Envejecido	672-1





**Bandeja negra de madera**

<u>MEDIDAS (cm)</u>	<u>REF.</u>
43*29*3,5	026293



**Bandeja negra de madera**

<u>MEDIDAS (cm)</u>	<u>REF.</u>
28*28*3	026294



**Bandeja compacta tipo cajón.  
1,5 cm grosor lateral**

<u>MEDIDAS (cm)</u>	<u>REF.</u>
60*40*7	750



**Bandeja bambú**

<u>MEDIDAS (cm)</u>	<u>REF.</u>
43*29*6,5	817



**Porta cubiertos & Sachets Bambú**

<u>MEDIDAS (cm)</u>	<u>REF.</u>
29*24*6	021704



**Porta cubiertos de Bambú natural**

<u>MEDIDAS (cm)</u>	<u>REF.</u>
15*15*15	021718



**Bandeja madera**

<u>MEDIDAS (cm)</u>	<u>REF.</u>
60*42*5	828ECO



**Bandeja de bar antideslizante redonda Olympia**

<u>MEDIDAS (mm)</u>	<u>MATERIAL</u>	<u>REF.</u>
305	INOX	DP207



**Fuente mariscos plateada**

<u>MEDIDAS (cm)</u>	<u>MATERIAL</u>	<u>REF.</u>
27,5*19*32	INOX	026210



**Fuente redonda**

<u>MEDIDAS (cm)</u>	<u>MATERIAL</u>	<u>REF.</u>
38,5	Aluminio	580



**Soporte expositor fuente**

<u>MEDIDAS (cm)</u>	<u>REF.</u>
20/25*20	467



### Bandeja tarjetera con pinza

MEDIDAS (cm)	REF.
13*8	661
21*12,5	662



### Fuente oval

MEDIDAS (cm)	REF.
25	191
30	192
40	193
45	194
50	196
60	197
80	198

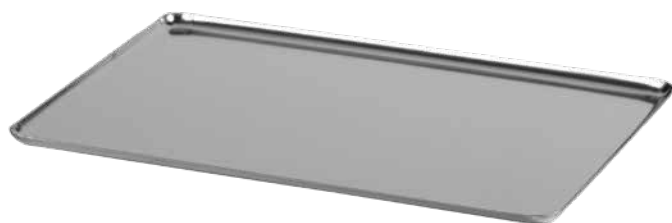

### Bandeja

MEDIDAS (cm)	MATERIAL	REF.
24*38	INOX	704
30*45	INOX	705



### Bandeja autoservicio INOX 18/10

MEDIDAS (cm)	CARACTERISTICAS	REF.
34*34	4 compartimentos	984
34*34*3.5	5 compartimentos	540



# MESA





### Tenedor de churrasco

MEDIDAS (cm)	REF.
21,5*4,5	353/1



### Hachuela churrasco

MEDIDAS (cm)	REF.
21,5*4,5	453



### Barbacoa de mesa rectangular

MEDIDAS (cm)	MATERIAL	REF.
34*23*21	Pintura especial anticorrosiva	471

### Barbacoa de mesa vitrificada redonda

MEDIDAS (cm)	MATERIAL	REF.
28	Acero esmaltado	470



### Pincho moruno extra largo

MEDIDAS (cm)	MATERIAL	REF.
76	Acero con mango de madera	497



### Navaja extra larga especial para tartas de boda

MEDIDAS	MATERIAL	REF.
1 metro	Acero con mango de madera	498



### Cubo de cava galvanizedo modelo aljibe

MEDIDAS (cm)	MATERIAL	REF.
19*15 capacidad 3 litros	Galvanizedo	473
23*18 capacidad 5 litros	Galvanizedo	474
25*20 capacidad 7 litros	Galvanizedo	475
27*22 capacidad 9 litros	Galvanizedo	476
29*25 capacidad 11 litros	Galvanizedo	477



### Cubo galvanizedo

MEDIDAS (cm)	MATERIAL	REF.
23*25 capacidad 11 litros	Acero galvanizedo	478
25*27 capacidad 14 litros	Acero galvanizedo	479
27*30 capacidad 18 litros	Acero galvanizedo	480

### Caldero galvanizedo



MEDIDAS (cm)	MATERIAL	REF.
14*13 capacidad 6 litros	Acero galvanizedo	481
16*35 capacidad 10 litros	Acero galvanizedo	483
17*40 capacidad 14 litros	Acero galvanizedo	484
20*45 capacidad 22 litros	Acero galvanizedo	485
28*75 capacidad 70 litros	Acero galvanizedo	486



Tartaleta

MEDIDAS (cm)	MATERIAL	REF.
7*2	INOX	524

Tenderete de madera de haya con barra de acero

MEDIDAS (cm)	MATERIAL	REF.
29*19,5*21	Madera de haya	42

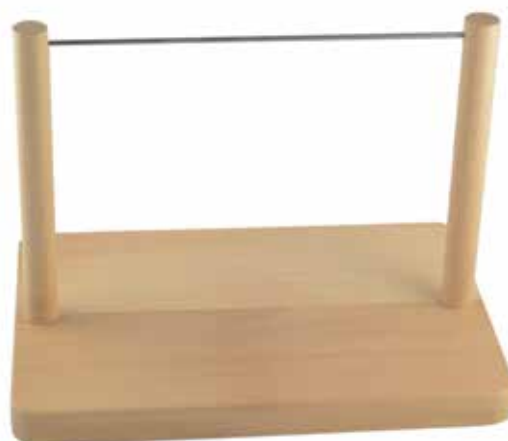

Pack 4 servilleteros cartón reciclado +100 servilletas bio-eco

MEDIDAS (cm)	MATERIAL	REF.
10,5*10,5	Cartón reciclado	070



### Servilletero de cóctel diseño

MEDIDAS (cm)	COLOR	MATERIAL	REF.
11,5*11,5*4	Negro	Metacrilato	527

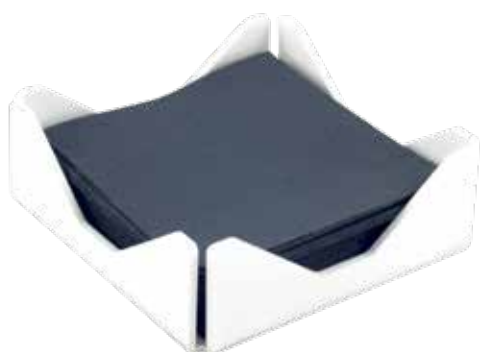

### Servilletero de cóctel diseño

MEDIDAS (cm)	COLOR	MATERIAL	REF.
11,5*11,5*4	Blanco	Metacrilato	530

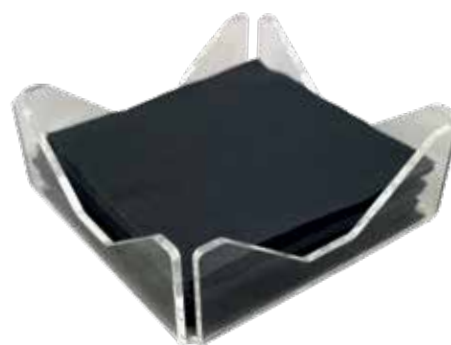

### Servilletero de cóctel diseño

MEDIDAS (cm)	COLOR	MATERIAL	REF.
11,5*11,5*4	Transparente	Metacrilato	530/1



### Servilletero de cóctel diseño HostelNovo

MEDIDAS (cm)	COLOR	MATERIAL	REF.
10*10	Transparente	Metacrilato	528
10*10	Negro	Metacrilato	528/1



Servilletero de cóctel forma caja

MEDIDAS (cm)	COLOR	MATERIAL	REF.
13*11*5	Negro	Metacrilato	529



Servilletero de cóctel forma caja

MEDIDAS (cm)	MATERIAL	REF.
10*10	Metacrilato	531



Servilletero de cóctel recto

MEDIDAS (cm)	COLOR	MATERIAL	REF.
10*10	Negro	Metacrilato	535



Servilletero de cóctel forma caja

MEDIDAS (cm)	MATERIAL	REF.
10*10	madera envejecida	884/1



Servilletero mini services c/ porta menú

MEDIDAS (cm)	COLOR	MATERIAL	REF.
14*11*9	Negro	Metacrilato	354



Dispensador de servilletas TORCK

MEDIDAS (cm)	REF.
14,5*19,10*30,7	db465



Servilletero de cóctel recto

MEDIDAS (cm)	COLOR	MATERIAL	REF.
11,5*11,5*4	Blanco	Metacrilato	533
11,5*11,5*4	Transparente	Metacrilato	534



Servilletero junior envejecido plano c/ porta menú

MEDIDAS (cm)	MATERIAL	REF.
14*11*9	madera envejecida	342/2



Servilletero junior negro plano c/ porta menú

MEDIDAS (cm)	MATERIAL	REF.
14*11*9	madera envejecida	342/4



Cajita servilleta

MEDIDAS (cm)	REF.
10*10	884



Servilletero madera

MEDIDAS (cm)	REF.
10,5*10,5*4,5	860
10,5*10,5*4,5	860-1
10,5*10,5*4,5	864
10,5*10,5*4,5	866



Servilletero bambú natural

MEDIDAS (cm)	REF.
13*13*10	025032



Servilletero junior

MEDIDAS (cm)	COLOR	REF.
10*9*13,5	Sapelly/ Madera	342



Servilletero junior envejecido

MATERIAL	REF.
Madera envejecida	342-2



Servilletero PVC

MEDIDAS (cm)	MATERIAL	REF.
10*10*10	Propileno	390



Servilletero metacrilato

MEDIDAS (cm)	MATERIAL	REF.
10*10*5	Metacrilato	388



Servilletero junior con porta carta

MEDIDAS (cm)	MATERIAL	REF.
10*9*13,5	INOX	690



386



666

### Servilleteros variados

MEDIDAS (cm)	MATERIAL	REF.
10,5*10,5*11	INOX	386
10*9*13,5	INOX	666



### Servilletero INOX c/ porta carta

MEDIDAS (ml)	MATERIAL	REF.
10*10	INOX	029



### Servilletero eco

MEDIDAS (cm)	REF
10*10	963



### Servilletero INOX

MEDIDAS (cm)	MATERIAL	REF.
10,5*10,5*7,2	INOX	391



### Soporte vinagrera sin saleros

COLOR	REF.
Natural	249
Envejecido	249-1

### Soporte vinagrera con salero

COLOR	REF.
Natural	250
Envejecido	250-1



### Caja vinagrera, salero y especiero

REF.

787



### Soporte de vinagrera sin saleros

MEDIDAS (cm)	COLOR	REF.
15*6*32	Negro	249.4

### Cajita vinagrera + salero/ especiero

REF.

870

872



### Caja vinagrera metacrilato

MEDIDAS (cm)	COLOR	MATERIAL	REF.
11*11*8,5	Negro	Metacrilato	526



**DOSIFICADORES EN SPRAY**  
**SPRAY DISPENSERS**

REF.	DESCRIPCION	COD. EAN	EMBALAJE
6007	DOSIFICADOR CRISTAL	8422309160070	48 ud
6008	DOSIFICADOR INOX	8422309160087	48 ud



**SET ACEITERA VINAGRERA / OIL AND VINEGAR SET**

REF.	DESCRIPCION	COD. EAN	EMBALAJE
2404	SET VINAGRERA 4PZS	8422309124041	12 ud



**DOSIFICADOR PULVERIZADOR / SPRAY DISPENSER**

REF.	DESCRIPCION	COD. EAN	EMBALAJE
4675	DOSIFICADOR PULVERIZADOR CRISTAL 470ml	8422309684675	24 ud





**ACEITERA CRISTAL ANTIGOTEO**  
**DRIP-FREE GLASS OIL DISPENSER**

REF.	MEDIDA	COD. EAN	EMBALAJE
AGV125	125 ml	8422309312370	12 ud
AGV250	250 ml	8422309312349	12 ud
AGV500	500 ml	8422309312356	12 ud
AGV750	750 ml	8422309 312615	12 ud



**ACEITERA CLÁSICA INOXIDABLE CÓNICA**  
**CLASSIC CONICAL STAINLESS STEEL OIL DISPENSER**

REF.	MEDIDA	COD. EAN	EMBALAJE
ILP	250 ml	8422309444415	12 ud
ILM	500 ml	8422309444422	12 ud

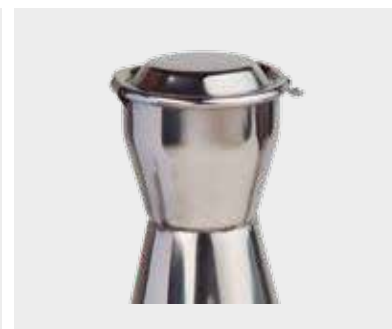

**ACEITERA INOXIDABLE ANTIGOTEO**  
**STAINLESS STEEL DRIP-FREE OIL DISPENSER**

REF.	MEDIDA	COD. EAN	EMBALAJE
AGP	250 ml	8422309323437	12 ud
AGM	500 ml	8422309323451	12 ud
AGG	750 ml	8422309323468	12 ud
AGXL	1000 ml	8422309323475	12 ud





Micro palet + Salero y especiero

MEDIDAS (cl)	COLOR	REF.
12*8*2,2	Blanco/negro	792



Micro palet. Salero + Especiero

MEDIDAS (cm)	REF.
12*8*2,2	924



Mini palet porta chupitos 4 agujeros

MEDIDAS (cm)	REF.
20*12*2,4	904



Micro palet porta chupitos

MEDIDAS (cm)	REF
12*8*2,2	923



Micro palet. Especial Tequila

MEDIDAS (cm)	REF.
12*8*2,2	887



Palet porta velas

MEDIDAS (cm)	MATERIAL	REF.
12*8*2,3	Madera color Wengue	922



Caja mini multiusos dos colores vintage

MEDIDAS (cm)	REF.
25*17*10	925/3



Caja cambio

MEDIDAS (cm)	REF
15*9*5	901



Caja madera.  
1 cm de grosor

MEDIDAS (cm)	REF
24,5*12,5*4	723



Cajita  
azucarillos- té

REF.
886



Cajita azucarillos- té

CANTIDAD (u)	REF.
10	888



Caja vinagrera + biberón

<u>MEDIDAS (cm)</u>	<u>REF.</u>
13*19*7	991



Caja vinagrera c/ saleros wengue

<u>MEDIDAS (cm)</u>	<u>COLOR</u>	<u>REF.</u>
11,5*11,5*8,5	Wengue	787-1



Porrón 1 Litro

<u>CAPACIDAD (ml)</u>	<u>REF.</u>
1000	312



Porrón 1/4 Litros

<u>CAPACIDAD (ml)</u>	<u>REF.</u>
250	312-1



Salero, Palillero,  
Especiero bobinga

	<u>MEDIDAS (cm)</u>	<u>MATERIAL</u>	<u>REF.</u>
Salero	9	INOX	281
Palillero	9	INOX	282
Especiero	9	INOX	283



Palillero de madera

<u>MEDIDAS (cm)</u>	<u>REF.</u>
7	262

Porta pajas



<u>MEDIDAS (cm)</u>	<u>MATERIAL</u>	<u>REF.</u>
4*10	INOX	683

Palillero



<u>MEDIDAS (cm)</u>	<u>MATERIAL</u>	<u>REF.</u>
2,5*5	INOX	207



Plato huevo  
o canalones

<u>REF.</u>
132
133

Papelera sobremesa



<u>MEDIDAS (cm)</u>	<u>MATERIAL</u>	<u>REF.</u>
Ø 7*12	INOX	99



Placa reservado camareros

MEDIDAS (cm)	MATERIAL	REF.
25*5*5	Metacrilato	678



Número mesa universal

MEDIDAS (cm)	MATERIAL	REF.
6*7,5*4,5	Acero / vinilo	109



Números mesa del 1-25

MEDIDAS (cm)	MATERIAL	REF.
6*4,5*4,5	Madera	011151



Soporte número banquete

MEDIDAS (cm)	MATERIAL	REF.
20	INOX	721
40	INOX	722



Pinza porta precios / números

MEDIDAS (cm)	MATERIAL	REF.
6	INOX	110
10,2	INOX	111



### Tetera Eliya

CAPACIDAD (L)	MATERIAL	REF.
0,8	Hierro fundido	631308

### Set tazas + 2 platillos

CAPACIDAD (L)	MATERIAL	REF.
0,2	Hierro fundido	624400



### Reposa teteras java

MEDIDAS (cm)	MATERIAL	REF.
15	Hierro fundido	621040



### Cuchara medidora para té macha

MEDIDAS (cm)	MATERIAL	REF.
11,8	INOX	667250



### Set macha 3 piezas bambú

MATERIAL	REF.
Bambú	667200



### Tetera Luxor

COLOR	MATERIAL	REF.
Negro	Porcelana/ INOX	668200B
Blanco	Porcelana/ INOX	668200W

### Hervidor eléctrico Luxe

CAPACIDAD (L)	MATERIAL	REF.
1,7	INOX	698800



### Cafetera silbante. 2,5 L

COLOR	MATERIAL	REF.
Negra	INOX	610425N
Blanca	INOX	6104250B



**TETERAS / TEAPOTS**

TETERAS hierro fundido (interior esmaltado)  
 Cast iron TEAPOTS (with enamelled interior)

CAPACIDAD / CAPACITY 0,30 LITRS

REF.	COLOR	COD. EAN	EMBALAJE
TEN	Negro / Black	8422309323246	12 ud
TEM	Marrón / Brown	8422309013000	12 ud
NA034	Roja / Red	8422309021401	12 ud
AZ034	Azul / Blue	8422309122160	12 ud
VE034	Verde / Green	8422309021425	12 ud

CAPACIDAD / CAPACITY 0,60 LITRS

REF.	COLOR	COD. EAN	EMBALAJE
TENG	Negro / Black	8422309021357	12 ud



**TETERAS / TEAPOTS**

TETERAS hierro fundido (interior esmaltado)  
 Cast iron TEAPOTS (with enamelled interior)

CAPACIDAD / CAPACITY 1 LITRS y 0,80 LITRS

REF.	COLOR	COD. EAN	EMBALAJE
SAKAI	Azul / Blue	8422309332330	6 ud
SAITAMA	Roja / Red	8422309332347	6 ud





**TETERAS / TEAPOTS**

TETERAS hierro fundido (interior esmaltado)  
Cast iron TEAPOTS (with enamelled interior)

Conjunto de tetera, vasos, reposavazos y reposatetera  
Teapot set with cups, coasters, and trivet

CAPACIDAD / CAPACITY 0,80 LITRS

REF.	COLOR	COD. EAN	EMBALAJE
HAKONE	Negro-Dorado/ Black-Gold	8422309332408	4 ud



**COMPLEMENTOS / ACCESSORIES**

COMPLEMENTOS para teteras / Accesories for teapots

REF.	MEDIDA	COD. EAN	EMBALAJE
RT034	Recambio filtro 0,34l. Inox.	8422309025232	40 ud
RT060	Recambio filtro 0,60l. Inox.	8422309025249	40 ud



RT034/RT060



151

REF.	DESCRIPCION	COD. EAN	EMBALAJE
150	Reposateteras 13 x 13 cm	8422309332354	24 ud
151	Juego de 2 vasos, capacidad 100 ml	8422309332361	12 ud
152	Juego de 2 reposavazos "hoja"	8422309332378	24 ud



150



152

**TETERAS-CAFETERA EMBOLO / TEAPOTS- COFEEMAKERS**

Teteras-cafeteras Borosilicato / Teapots-cofeemarkers Borosilicate

**MODELO "LIZ" / "LIZ" MODEL**

REF.	MODELO	COD. EAN	EMBALAJE
2402	Francesa LIZ 600 ml	8422309124027	12 ud



**MODELO "SIAH" / "SIAH" MODEL**

REF.	MODELO	COD. EAN	EMBALAJE
2405	Francesa SIAH 350 ml	8422309124058	12 ud
2406	Francesa SIAH 600 ml	8422309124065	12 ud





**TETERAS-CAFETERA EMBOLO / TEAPOTS- COFEEMAKERS**

Teteras-cafeteras Borosilicato / Teapots-cofeemarkers Borosilicate

CAPACIDAD 1 LITROS

REF.	MODELO	COD. EAN	EMBALAJE
2403	Francesa ONA	8422309124034	12 ud



**FILTRO / FILTERS**

Filtro para te con tapa de silicona / Tea filter with silicone lid

REF.	DESCRIPCION	COD. EAN	EMBALAJE
6001	Filtro para te en acero inox.	8422309160018	48 ud



**IFUSOR / TEA INFUSER**

Infusor de té inox 18/10 / 304 s/s Tea infuser

REF.	DESCRIPCION	COD. EAN	EMBALAJE
4538	Infusor de té 4,5 cm / Tea infusor 4,5 cm	8422309684538	48 ud
4545	Infusor de té 6,5 cm / Tea infusor 6,5 cm	8422309684545	48 ud



**JARRA DE LECHE / MILK POT**

Jarra de leche inox 18/10 / 304 Stainless Steel Milk Pot

REF.	DESCRIPCION	COD. EAN	EMBALAJE
2407	Jarra leche inox 18/10 con escala medidora 350ml	8422309124072	24 ud
1052	Jarra leche inox 18/10 con escala medidora 660ml	8422309001052	24 ud





Jarra Bristol

<u>MEDIDAS (ml)</u>	<u>MATERIAL</u>	<u>REF.</u>
250	INOX	179
500	INOX	180
1000	INOX	181



Tetera Bristol con filtro

<u>MEDIDAS (ml)</u>	<u>MATERIAL</u>	<u>REF.</u>
500	INOX	184



Pizarra soporte

<u>MEDIDAS (cm)</u>	<u>REF.</u>
23*14,5	252



Cenicero agua plano

<u>MEDIDAS (cm)</u>	<u>MATERIAL</u>	<u>REF.</u>
8,6*4,5	INOX	161



Cenicero agua

<u>MEDIDAS (cm)</u>	<u>MATERIAL</u>	<u>REF.</u>
9*6	INOX	162



Soporte salero REF.  
+ especiero 53



Salero windsor

COLOR	REF.
Blanco	107



Salero facetas

MEDIDAS (cm)	MATERIAL	REF.
4*6	Cristal	97



Salero Windsor tapón INOX

MEDIDAS (cm)	MATERIAL	REF.
4, 5	Cristal	104



Especiero Windsor tapón INOX

MEDIDAS (cm)	MATERIAL	REF.
4, 5	Cristal	105



Azucarero dosificador

MEDIDAS (cm)	MATERIAL	REF.
7,5*14	Cristal	123



Salero cocina

<u>MEDIDAS (cm)</u>	<u>MATERIAL</u>	<u>REF.</u>
7,5*14	Cristal	124



Espolvoreador de queso

<u>MEDIDAS (cm)</u>	<u>MATERIAL</u>	<u>REF.</u>
7,5*14	Cristal	125



Gazpacho 5 recipientes

<u>REF.</u>
596



Juego azúcar 3 servicios

<u>REF.</u>
620



Juego azúcar 2 servicios

<u>REF.</u>
621



Azucarero rotativo 3 servicios sin tapa

<u>MEDIDAS (cm)</u>	<u>MATERIAL</u>	<u>REF.</u>
20*23	Cristal	730



Molinillo pimienta

MEDIDAS (cm)	MATERIAL	REF.
16,5	Madera	370
21	Madera	371
26,5	Madera	372



Molinillo salero 12 cm

MEDIDAS (cm)	COLOR	REF.
12	Negro/Madera	373



Molinillo pimienta

MEDIDAS (cm)	MATERIAL	REF.
21,5	Madera/ Cerámica	371.1



Molinillo pimienta

MEDIDAS (cm)	MATERIAL	REF.
27	Madera/ Cerámica	371.2



277

Molinillo madera

MEDIDAS (cm)	REF.
30	275
21	277



Molinillo madera

<u>MEDIDAS (cm)</u>	<u>REF.</u>
40	278



Molinillo madera gigante

<u>MEDIDAS (cm)</u>	<u>REF.</u>
61	278-1



Cuchara de miel

<u>MEDIDAS (cm)</u>	<u>REF.</u>
17,5	1028



Brocheta oval

<u>MEDIDAS (cm)</u>	<u>MATERIAL</u>	<u>REF.</u>
20	INOX	1
28	INOX	2
44	INOX	27



Brocheta florete

<u>MEDIDAS (cm)</u>	<u>MATERIAL</u>	<u>REF.</u>
25	INOX	47
40	INOX	48



Cuchillo ostras

MEDIDAS (cm)	MATERIAL	REF.
16	Mango plástico	101



Cuchillo quesos

MEDIDAS (cm)	MATERIAL	REF.
28,5*3,5	INOX	163



Tijera rompe-marisco "Eco"

REF.
396



Recoge migas

MEDIDAS (cm)	MATERIAL	REF.
17*17 (pala) 30 (mango)	INOX	320



Recoge migas bolígrafo

MEDIDAS (cm)	MATERIAL	REF.
20	INOX	321



Cuchillo queso

MEDIDAS (cm)	REF.
20	609



Tijera rompe marisco recta

MEDIDAS (cm)	MATERIAL	REF.
17	INOX	392



Copa helado

MEDIDAS (cm)	MATERIAL	REF.
10	INOX	805



Sopera con base

MEDIDAS (cm)	MATERIAL	REF.
24	INOX	806

Envase para bebidas calientes

MEDIDAS (cm)	MATERIAL	REF.
3	Cartón y plástico	22
5	especial	23



Cubo

MEDIDAS (cm)	MATERIAL	REF.
21	Acero galvanizado	986
23	Acero galvanizado	987
26	Acero galvanizado	988
30 (10L)	Acero galvanizado	988/1



### Campana esférica

MEDIDAS (cm)	MATERIAL	REF.
25	Metacrilato	427
40	Metacrilato	423



253



254

### Tapa campana

MEDIDAS (cm)	MATERIAL	REF.
30	Metacrilato	253
30	INOX	254



### Tapa para plancha

MEDIDAS (cm)	REF.
15,5	713914



### Tapa para plancha

MEDIDAS (cm)	REF.
23,2	713900



Campana tarta

MEDIDAS (cm)	REF.
31,5*6,5	216



Cubre platos

MEDIDAS (cm)	MATERIAL	REF.
26	INOX	679



Cubierta de plato de policarbonato

REF.
K483



Tapa para platos de plástico

REF.
K499

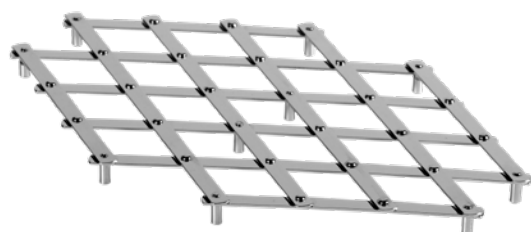

Salva mantel extensible

MEDIDAS (cm)	MATERIAL	REF.
27*27	INOX	149



Hornillo Rechaud rústico

REF.
4272291



Plato hierro fundido

<u>MEDIDAS</u> (cm)	<u>REF.</u>
26	99743001



Base de madera para plato de hierro

<u>MEDIDAS</u> (cm)	<u>REF.</u>
26	62700



Recarga de gas para hornillo Rechaud

<u>REF.</u>
4279901



Recambio de gas para cabezal soplete

<u>CAPACIDAD</u> (ml)	<u>REF.</u>
600	727060



Cabezal soplete profesional

<u>REF.</u>
786600



# COCINA





Espátula para wok

REF.

762058



CM070450



070465



Paleta Valenciana

MEDIDAS (cm)	MATERIAL	REF.
50	INOX	CM070450
65	INOX	070465

Espátula

MEDIDAS (cm)	MATERIAL	REF.
50	Madera	273.1



Paleta Valenciana

MEDIDAS (cm)	MATERIAL	REF.
50	INOX	070550



Paleta Valenciana mango madera

MEDIDAS (cm)	MATERIAL	REF.
65	INOX	070565



### Colador chino mango de exoglass

MEDIDAS (cm)	MATERIAL	REF.
41*20,3	Acero	w693



### Embolsador de patatas

COLOR	MATERIAL	REF.
Gris	ABS	l681

### Partidor de nueces y almendras

MEDIDAS (cm)	MATERIAL	REF.
25*18	Metal	472



### Sartén honda vitrificada con mango



MEDIDAS (cm)	MATERIAL	REF.
22	Acero esmaltado	514
24	Acero esmaltado	515
26	Acero esmaltado	516
28	Acero esmaltado	517
36	Acero esmaltado	518



Navaja jamonera mango recto

MEDIDAS (cm)	COLOR	REF.
15	Marrón	519



Navaja jamonera mango recto de fibra

MEDIDAS (cm)	COLOR	REF.
15	Blanco	520



Sacacorchos

MEDIDAS (cm)	MATERIAL	REF.
12*2	INOX	4



Asadora esmaltada de inducción

MEDIDAS (cm)	MATERIAL	REF.
22	Acero esmaltado	521
24	Acero esmaltado	522
26	Acero esmaltado	523

Plancha de hierro fundido doble cara lisa y ondulada

MEDIDAS (cm)	COLOR	MATERIAL	REF.
44*24	Negro	Hierro fundido	487





### Pala crema manual

MEDIDAS (cm)	MATERIAL	REF.
10 de diámetro	Hierro con mango de madera	441



### Buñelera

MEDIDAS (cm)	MATERIAL	REF.
9 de diámetro	Hierro con mango de madera	488



### Pala para hacer migas

MATERIAL	REF.
INOX	490



663



665

### Molde helado

MEDIDAS	MATERIAL	REF.
16 porciones	Aluminio	663
20 porciones	Aluminio	664
20 porciones	INOX	665



### Molde helado

MEDIDAS (cm)	REF.
55	658
45	659



Sartén honda pulida con mango

MEDIDAS (cm)	REF.
26	33156
28	33157
30	33158
40	33163



Sartén con mango largo

MEDIDAS (cm)	REF.
36	33170
40	33172
50	33174



Sartén honda pulida con patas desmontables

MEDIDAS (cm)	REF.
26	32986
40	32988



Sartén honda vitrificada con 2 asas

MEDIDAS (cm)	REF.
16	32927
20	32929
24	32931
30	32934



Caldero de hierro

MEDIDAS (cm)	REF.
220*110 3 litros	3301
240*220 4 litros	3304
360*180 10 litros	3306



### Molde huevo

MEDIDAS (cm)	MATERIAL	REF.
8*8*2	cuadrado asa plegable	18
8*2	redondo plegable	19

### Molde regulable

MEDIDAS (cm)	MATERIAL	REF.
7 - 9	redondo	167
6 - 9	cuadrado	168
8 - 12	triangular	169

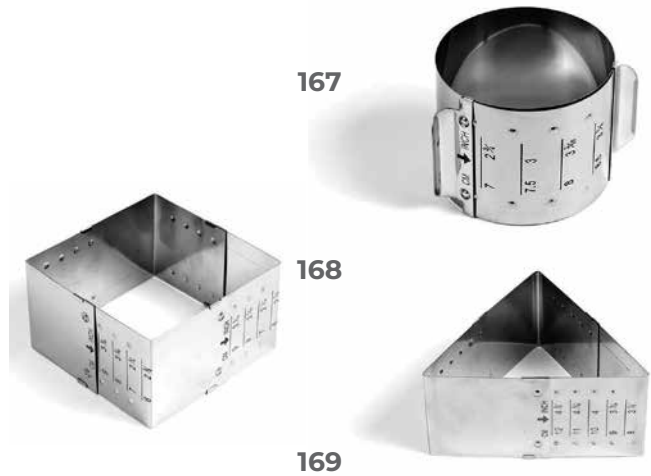

### Molde nido

MEDIDAS (cm)	MATERIAL	REF.
8	INOX	670
10	INOX	671



### Molde hamburguesas

MEDIDAS (cm)	REF.
10	134



## Prensa de hamburguesas 140mm

MEDIDAS (cm)	REF.
14*14*7,5	326

- Mango antideslizante · Soldadura láser
- Fácil de limpiar



Ideal para fundir el queso y calentar hamburguesas evitando la cocción de la carne

## Campana hamburguesa INOX

MEDIDAS (cm)	REF.
Ø 16	513

- Mango hergonómico · Fácil agarre
- A prueba de quemaduras



## Rueda esparcidora de mantequilla

MEDIDAS (cm)	MATERIAL	REF.
17,5*16*10	INOX	512

Facilita untar la mantequilla de manera más uniforme en rebanadas de pan, bollos y mazorcas.



- Almacena hasta 1L de mantequilla.
- Desmontable para su limpieza.
- Apta para lavavajillas



## Tarro de barro

MEDIDAS (cm)	REF.
7*7,5	495



### Barro cazuela baja

MEDIDAS (cm)	COLOR	REF.
10	Negra	492
14	Negra	493
18	Negra	494



### Cazuela crema catalana

MATERIAL	MEDIDAS (cm)	REF.
Barro cocido	10	496
Barro cocido	12	496/1



### Pala quemar crema desmontable

CARACT.	MATERIAL	REF.
600 w	Disco INOX	405
1000 w	Disco INOX	406

### Wok base plana Vogue

MEDIDAS	REF.
330 mm	K296

### Wok base plana Vogue Mild Steel

MEDIDAS	REF.
356 mm	K297





Espumadera f/ cazo

MATERIAL	MEDIDAS (cm)	REF.
Madera	24	463

Espumadera mixta

MEDIDAS (cm)	REF.
14	536
16	537
18	538



Espumadera alambre

MEDIDAS (cm)	MATERIAL	REF.
14	INOX	71
16	INOX	72
18	INOX	73
20	INOX	74



Cazo alambre

MEDIDAS (cm)	MATERIAL	REF.
22	INOX	626
30	INOX	630
32	INOX	631



Corta pizza

REF.
63

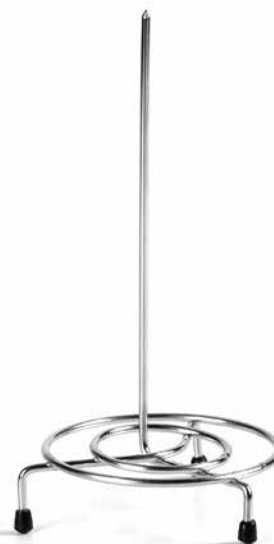

Pincho minuta

MEDIDAS (cm)
Ø 8 *18
MATERIAL
INOX
REF.
508



## Cacillo salsas

MEDIDAS (cm)	MATERIAL	REF.
14*5	INOX	114

## Cacillo aceitunas

MEDIDAS (cm)	MATERIAL	REF.
29,5* Ø 6	INOX	45



## Rasqueta plancha universal

MEDIDAS (cm)	CARACT.	REF.
28*11	INOX	397



## Rasqueta plancha profesional

MEDIDAS (cm)	CARACT.	REF.
30	INOX	001035

## Cuchilla recambio

CANTIDAD	CARACT.	REF.
10 ud	INOX	398



## Triángulo chino

MATERIAL	REF.
Madera	421

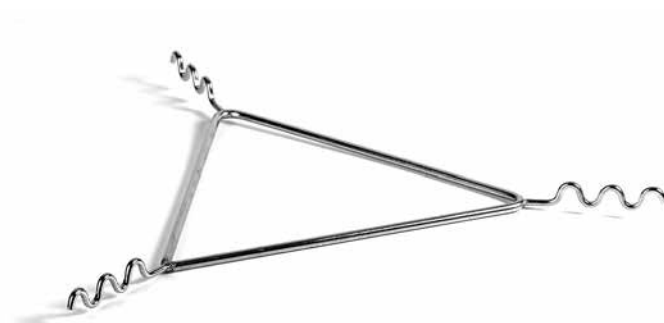

## Triángulo para colador chino

MEDIDAS (cm)	MATERIAL	REF.
40/27*2	INOX	506



Espetos

MEDIDAS (cm)	MATERIAL	REF.
22,5*16,5	INOX	57



Gancho carne

MEDIDAS (cm)	MATERIAL	REF.
12	INOX	11
17	INOX	12
28	INOX	12-1



Quemador alcohol

MATERIAL	REF.
Acero niquelado	401



Colador chino c/ dosificador

MEDIDAS (cm)	REF.
18,5	983



Germinador de semillas

REF.
36

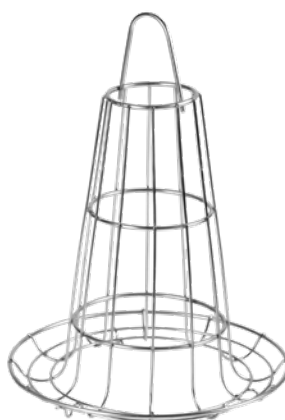

Expositor longaniza

REF.
702



Limpia-vasos

MATERIAL	REF.
Plástico	1023



### Mini cubeta negra rectangular

MEDIDAS (cm)	MATERIAL	REF.
13,7*9,2*3,8 (17,8 con asas)	Hierro fundido	643



### Mini sartén

MEDIDAS (cm)	MATERIAL	REF.
10*3	INOX	641
12,7	Hierro fundido	650



### Mini cazuelas redondas con asas

MEDIDAS (cm)	COLOR	REF.
Ø 16,9	Hierro fundido	652
Ø 18	Hierro fundido	653



### Mini cazuelas redondas con tapas

MEDIDAS (cm)	COLOR	REF.
Ø 10	Hierro fundido	654
Ø 14	Hierro fundido	655



### Mini cazuela c/ tapa

MEDIDAS (cm)	REF.
Ø 12,7	651



### Plato campestre + base madera

MEDIDAS (cm)	REF.
22	667



### **OLLA INOXIDABLE 18/10 304 STAINLESS STEEL POT**

Olla inoxidable, fondo difusor capsulado, inducción  
*Stainless steel pot, encapsulated heat-diffusing base, induction*

REF.	MEDIDA	CAPACIDAD	COD. EAN	EMBALAJE
OI16	16*15 cm	3 l	8422309143202	4 ud
OI18	18*16 cm	4 l	8422309031110	4 ud
OI20	20*17 cm	5,3 l	8422309031127	4 ud
OI22	22*18 cm	6,8 l	8422309031134	4 ud
OI24	24*19 cm	8,6 l	8422309031349	4 ud
OI26	26*20 cm	10,6 l	8422309031158	2 ud
OI28	28*21 cm	12,9 l	8422309031165	2 ud
OI30	30*22 cm	15 l	8422309143035	2 ud
OI32	32*23 cm	18,5 l	8422309151016	2 ud



### **OLLA ALTA INOXIDABLE 18/10 304 STAINLESS STEEL STOCK POT**

Olla Alta inoxidable, fondo difusor capsulado, inducción  
*Stainless steel stock pot, encapsulated heat-diffusing base, induction*

REF.	MEDIDA	CAPACIDAD	COD. EAN	EMBALAJE
OA20	20*20 cm	7,5 l	8422309684644	4 ud
OA24	24*24 cm	10,8 l	8422309684651	4 ud
OA28	28*28 cm	16,9 l	8422309684668	2 ud



### **OLLA ALTA INOXIDABLE 18/10 304 STAINLESS STEEL STOCK POT**

Olla Alta inoxidable, fondo difusor capsulado, inducción  
*Stainless steel stock pot, encapsulated heat-diffusing base, induction*

REF.	MEDIDA	CAPACIDAD	COD. EAN	EMBALAJE
OA20	20*20 cm	7,5 l	8422309684644	4 ud
OA24	24*24 cm	10,8 l	8422309684651	4 ud
OA28	28*28 cm	16,9 l	8422309684668	2 ud





### TARTERA INOXIDABLE 18/10 304 STAINLESS STEEL LOW CASSEROLE

Tartera inoxidable, fondo difusor capsulado, inducción  
*Stainless steel low casserole, full induction base*

REF.	MEDIDA	COD. EAN	EMBALAJE
200-16	16*6 cm	8422309231398	4 ud
200-18	18*6 cm	8422309231404	4 ud
200-20	20*6 cm	8422309231411	4 ud
200-22	22*6 cm	8422309231428	4 ud
200-24	24*6 cm	8422309231435	4 ud
200-26	26*6,5 cm	8422309231442	4 ud
200-28	28*6,5 cm	8422309231459	4 ud
200-30	30*6,5 cm	8422309231466	4 ud
200-32	32*7 cm	8422309231473	4 ud



### CACEROLA INOXIDABLE 18/10 304 STAINLESS STEEL CASSEROLE

Cacerola inoxidable, fondo difusor capsulado, inducción  
*Stainless steel casserole, full induction base*

REF.	MEDIDA	CAPACIDAD	COD. EAN	EMBALAJE
CI12	12*7cm	0,8 l	8422309141017	4 ud
CI14	14*7,5 cm	1,1 l	8422309142403	4 ud
CI16	16*7,5 cm	1,5 l	8422309143042	4 ud
CI18	18*8 cm	2,0 l	8422309014212	4 ud
CI20	20*8,5 cm	2,6 l	8422309142229	4 ud
CI22	22*9 cm	3,4 l	8422309142304	4 ud
CI24	24*9,5 cm	4,3 l	8422309142311	4 ud
CI26	26*10 cm	5,3 l	8422309142328	4 ud
CI28	28*11 cm	6,8 l	8422309142335	4 ud
CI30	30*12 cm	8,5 l	8422309142502	4 ud
CI32	32*12 cm	10,4 l	8422309142519	2 ud



### CAZO INOXIDABLE 18/10 304 STAINLESS STEEL SAUCE POT

Cazo inoxidable, fondo difusor capsulado, inducción  
*Stainless steel sauce pot, full induction base*

REF.	MEDIDA	CAPACIDAD	COD. EAN	EMBALAJE
CAI12	12x8,50 cm	1 l	8422309142359	6 ud
CAI14	14x8,50 cm	1,3 l	8422309142366	6 ud
CAI16	16x8 cm	1,6 l	8422309142373	6 ud
CAI18	18x8 cm	2,0 l	8422309142380	4 ud
CAI20	20x8,5 cm	2,6 l	8422309180160	4 ud





**SARTÉN ACERO INOXIDABLE 18/10, "ESSENTIA"  
"ESSENTIA", 304 STAINLESS STEEL PAN**

Fondo inducción sistema "Full induction" / Full induction base

REF.	MEDIDA	COD. EAN	EMBALAJE
SE20	20 cm	8422309684606	4 ud
SE22	22cm	8422309685139	4 ud
SE24	24 cm	8422309684613	4 ud
SE26	26 cm	8422309685214	4 ud
SE28	28 cm	8422309684620	4 ud



**VAPORERA INOXIDABLE 18/10  
304 STAINLESS STEEL STEAMER**

REF.	MEDIDA	COD. EAN	EMBALAJE
201-20	20 cm	8422309231480	4 ud
201-24	24 cm	8422309231497	4 ud



**RUSTIDERA INOXIDABLE 18/10  
304 STAINLESS STEEL ROASTING PAN**

REF.	MEDIDA	COD. EAN	EMBALAJE
RU45	35 * 24 * 10 cm	8422309003919	2 ud





**POTE INOXIDABLE 18/10**  
**304 STAINLESS STEEL MILK POT**

Fondo "Full induction" / Full induction base

REF.	MEDIDA	COD. EAN	EMBALAJE
504-14	14*12 cm	8422309143011	6 ud
504-16	16*13 cm	8422309143028	6 ud



**POTE INOXIDABLE**  
**STAINLESS STEEL MILK POT**

Fondo "Full induction" / Full induction base

REF.	MEDIDA	CAPACIDAD	COD. EAN	EMBALAJE
Q12	12*10 cm	1,1 l	8422309124300	6 ud
Q14	14*12 cm	1,8 l	8422309124317	6 ud
Q16	16*13 cm	2,6 l	8422309124324	6 ud
Q18	18*14 cm	3,2 l	8422309124348	6 ud



**TAPA ACERO INOXIDABLE / STAINLESS STEEL LID**

REF.	MEDIDA	COD. EAN	EMBALAJE
TA20	20 cm	8422309001373	24 ud
TA22	22 cm	8422309002714	24 ud
TA24	24 cm	8422309001007	24 ud
TA26	26 cm	8422309002721	24 ud
TA28	28 cm	8422309001014	24 ud
TA30	30 cm	8422309002745	24 ud
TA32	32 cm	8422309002752	24 ud





**CAZO INOXIDABLE, MANGO BAQUELITA**  
**STAINLESS STEEL SAUCE POT WITH BAKELITE**  
**HANDLE**

Fondo "Full induction" / Full induction base

REF.	MEDIDA	COD. EAN	EMBALAJE
K12	12*7,5 cm	8422309180153	6 ud
K14	14*7,5 cm	8422309080118	6 ud
K16	16*8,5 cm	8422309080125	6 ud
K18	18*8,8 cm	8422309154123	6 ud
K20	20*8,8 cm	8422309080149	6 ud



**CAZO FREIDOR INOXIDABLE CON CESTILLO**  
**STAINLESS STEEL FRYING POT, BAKELITE HANDLE**  
**AND BASKET**

Fondo "Full induction" y mango baquelita  
 Full induction base and bakelite handle

REF.	MEDIDA	COD. EAN	EMBALAJE
K18B	18*9,5 cm	8422309080910	6 ud



**OLLA INOXIDABLE / STAINLESS STEEL POT**

Fondo Capsulado Full Induction / Full induction base

REF.	MEDIDA	CAPACIDAD	ESPESOR	COD. EAN	EMBALAJE
B18	18*16 cm	4 l	0,5mm	8422309080200	4 ud
B20	20*17 cm	5,3 l	0,5mm	8422309080217	4 ud
B22	22*18 cm	6,8 l	0,5mm	8422309080224	4 ud
B24	24*19 cm	8,6 l	0,5mm	8422309080231	4 ud
B26	26*20 cm	10,6 l	0,5mm	8422309080248	2 ud
B28	28*21 cm	12,9 l	0,5mm	8422309080255	2 ud
B30	30*22 cm	15 l	0,5mm	8422309080262	2 ud





### CACEROLA INOXIDABLE / STAINLESS STEEL CASSEROLE

Fondo Capsulado Full Induction / Full induction base

REF.	MEDIDA	CAPACIDAD	ESPEJOR	COD. EAN	EMBALAJE
M18	18*8 cm	2 l	0,5mm	8422309144124	4 ud
M20	20*8,5 cm	2,6 l	0,5mm	8422309143127	4 ud
M22	22*9 cm	3,4 l	0,5mm	8422309143134	4 ud
M24	24*9,5 cm	4,3 l	0,5mm	8422309144131	4 ud
M26	26*10 cm	5,3 l	0,5mm	8422309143158	4 ud
M28	28*11 cm	6,8 l	0,5mm	8422309143165	4 ud
M30	30*12 cm	8,5 l	0,5mm	8422309143172	4 ud



### OLLA INOXIDABLE, "MODENA" "MODENA", STAINLESS STEEL POT

Fondo Capsulado Full Induction / Full induction base

REF.	MEDIDA	CAPACIDAD	ESPEJOR	COD. EAN	EMBALAJE
RI20	20*14 cm	4,4 l	0,6mm	8422309124607	4 ud
RI22	22*15 cm	5,34 l	0,6mm	8422309124614	4 ud
RI24	24*18 cm	8,14 l	0,6mm	8422309124621	4 ud
RI26	26*20 cm	10,62 l	0,6mm	8422309124638	2 ud
RI28	28*22 cm	13,54 l	0,6mm	8422309124645	2 ud



### CACEROLA INOXIDABLE, "MODENA" "MODENA", STAINLESS STEEL CASSEROLE

Fondo Capsulado Full Induction / Full induction base

REF.	MEDIDA	CAPACIDAD	ESPEJOR	COD. EAN	EMBALAJE
SI20	20*6 cm	1,88 l	0,6mm	8422309124539	4 ud
SI22	22*7 cm	2,66 l	0,6mm	8422309124546	4 ud
SI24	24*8 cm	3,62 l	0,6mm	8422309124553	4 ud
SI26	26*9 cm	5,3 l	0,6mm	8422309124560	2 ud
SI28	28*10 cm	6,8 l	0,6mm	8422309124577	2 ud





**OLLA RECTA PROFESIONAL, ACERO INOXIDABLE 18/10  
304 STAINLESS STEEL PROFESSIONAL STRAIGHT POT**

Fondo tipo sandwich en 4.0 mm. Apta inducción  
4.0 mm triple-layer base. Suitable for induction

REF.	DIÁMETRO	ALTURA	ESPESOR	CAPACIDAD	COD. EAN	EMBALAJE
800-20	20 cm	20 cm	0,8 mm	6,2 l	8422309172103	4 ud
800-24	24 cm	24 cm	0,8 mm	10,8 l	8422309172219	4 ud
800-28	28 cm	28 cm	0,8 mm	17,2 l	8422309170246	2 ud
800-32	32 cm	32 cm	1,0 mm	25,7 l	8422309161206	2 ud
800-36	36 cm	36 cm	1,0 mm	36,6 l	8422309161213	1 ud
800-40	40 cm	40 cm	1,0 mm	50,2 l	8422309171342	1 ud



**CACEROLA ALTA PROFESIONAL, ACERO INOXIDABLE 18/10  
304 STAINLESS STEEL PROFESSIONAL CASSEROLE**

Fondo tipo sandwich en 4.0 mm. Apta inducción  
4.0 mm triple-layer base. Suitable for induction

REF.	DIÁMETRO	ALTURA	ESPESOR	CAPACIDAD	COD. EAN	EMBALAJE
810-28	28 cm	17,5 cm	0,8 mm	10,2 l	8422309170215	2 ud
810-32	32 cm	18 cm	0,8 mm	14,5 l	8422309170239	2 ud
810-36	36 cm	21,5 cm	1,0 mm	22 l	8422309170222	2 ud
810-40	40 cm	24 cm	1,0 mm	31 l	8422309171670	1 ud



**CAZO INOXIDABLE PROFESIONAL 18/10  
304 PROFESSIONAL STAINLESS STEEL SAUCEPAN**

Fondo tipo sandwich en 4.0 mm. Apta inducción  
4.0 mm triple-layer base. Suitable for induction

REF.	DIÁMETRO	ALTURA	ESPESOR	CAPACIDAD	COD. EAN	EMBALAJE
820-16	16 cm	11 cm	0,8 mm	2.1 l	8422309170253	4 ud
820-20	20 cm	13 cm	0,8 mm	4.0 l	8422309170260	2 ud





**CACEROLA ALUMINIO FUNDIDO "ONIX" ANTIHADERENTE CERÁMICO ILAG "ONIX", DIE-CAST ALUMINIUM CASSEROLE ILAG CERAMIC NON-STICK**

Fondo inducción sistema "Full induction"  
Full induction base

REF.	MEDIDA	COD. EAN	EMBALAJE
902-28	28*7,5 cm	8422309289023	4 ud
902-32	32*8 cm	8422309329026	4 ud
902-36	36*9 cm	8422309369022	4 ud



**SARTEN ALUMINIO FUNDICIÓN, "ONIX" "ONIX", DIE-CAST ALUMINIUM FRYING PAN**

Fondo inducción sistema "Full induction"  
Full induction base

REF.	MEDIDA	COD. EAN	EMBALAJE
102-18	18 cm	8422309181020	6 ud
102-20	20 cm	8422309201025	6 ud
102-22	22 cm	8422309221023	6 ud
102-24	24 cm	8422309241021	6 ud
102-26	26 cm	8422309261029	6 ud
102-28	28 cm	8422309281027	6 ud



**CACEROLA BAJA ALUMINIO FUNDIDO, "BRENDA" "BRENDA", DIE-CAST ALUMINIUM CASSEROLE**

Fondo inducción sistema "Full induction"  
Full induction base

REF.	MEDIDA	COD. EAN	EMBALAJE
802-24	24*7,5 cm	8422309002295	4 ud
802-28	28*7,5 cm	8422309002301	4 ud
802-32	32*8 cm	8422309000949	4 ud
802-36	36*9 cm	8422309000956	2 ud
802-40	40*9 cm	8422309323420	2 ud



**OLLA ALUMINIO FUNDIDO, " BRENDA" "BRENDA", DIE-CAST ALUMINIUM POT**

Fondo inducción sistema "Full induction"  
Full induction base

REF.	MEDIDA	COD. EAN	EMBALAJE
801-16	16*8 cm	8422309566025	4 ud
801-20	20 *10 cm	8422309566032	4 ud
801-24	24 *11 cm	8422309566049	4 ud
801-28	28 *12 cm	8422309566056	4 ud
801-32	32 *14 cm	8422309032346	4 ud





### ASADORES ALUMINIO FUNDICIÓN DIE-CAST ALUMINIUM GRIDDLE PAN

Asador LISO fondo inducción sistema "Full induction"  
Smooth griddle pan, full induction base

REF.	MEDIDA	COD. EAN	EMBALAJE
619L	20*20 cm	8422309092326	6 ud
620L	24*24 cm	8422309092333	6 ud
621L	28*28 cm	8422309092340	6 ud
622-RL	36*25 cm	8422309092357	6 ud



### ASADORES ALUMINIO FUNDICIÓN DIE-CAST ALUMINIUM GRILL PAN

Asador ONDULADO fondo inducción sistema "Full induction"  
Ribbed grill pan, full induction base

REF.	MEDIDA	COD. EAN	EMBALAJE
619	20*20 cm	8422309002257	6 ud
620	24*24 cm	8422309000925	6 ud
621	28*28 cm	8422309002271	6 ud
622-R	36*25 cm	8422309000932	6 ud



### RUSTIDERA R35 DIE-CAST ALUMINIUM ROAST PAN

Rustidera aluminio fundido "Full Induction"  
Roast pan, full induction base

REF.	MEDIDA	COD. EAN	EMBALAJE
R35	35 cm	8422309566124	6 ud





**SARTÉN ALUMINIO FORJADO, "COBRE"**  
**"COBRE", FORGED ALUMINIUM FRYING PAN**

Fondo inducción sistema "Full induction"  
 Full induction base

REF.	MEDIDA	COD. EAN	EMBALAJE
911-16	16 cm	8422309022361	6 ud
911-18	18 cm	8422309170277	6 ud
911-20	20 cm	8422309170284	6 ud
911-22	22 cm	8422309170291	6 ud
911-24	24 cm	8422309170307	6 ud
911-26	26 cm	8422309170314	6 ud
911-28	28 cm	8422309170321	6 ud
911-30	30 cm	8422309170338	6 ud



**SARTÉN HONDA ALUMINIO FORJADO, "COBRE"**  
**"COBRE" FORGED ALUMINIUM DEEP FRYING PAN**

Fondo inducción sistema "Full induction"  
 Full induction base

REF.	MEDIDA	COD. EAN	EMBALAJE
912-24	24 cm	8422309170345	4 ud
912-28	28 cm	8422309170352	4 ud
912-32*	32 cm	8422309170369	4 ud

\*Contiene asa auxiliar extra / includes an auxiliary handle



**CACEROLA ALUMINIO FORJADO, "COBRE"**  
**"COBRE" FORGED ALUMINIUM CASSEROLE**

Fondo inducción sistema "Full induction"  
 Full induction base

REF.	MEDIDA	COD. EAN	EMBALAJE
913-28	28 cm	8422309170376	4 ud
913-32	32 cm	8422309170383	4 ud



**ASADOR ALUMINIO FORJADO, "COBRE"**  
**"COBRE", FORGED ALUMINIUM GRILL PAN**

Fondo inducción sistema "Full induction"  
 Full induction base

REF.	MEDIDA	COD. EAN	EMBALAJE
914-27	27 cm	8422309170390	6 ud





**CREPERA ALUMINIO FORJADO, "COBRE"**  
**"COBRE", FORGED ALUMINIUM CREPE PAN**

Fondo inducción sistema "Full induction"

*Full induction base*

REF.	MEDIDA	COD. EAN	EMBALAJE
915-28	28 cm	8422309170505	6 ud



**CAZO ALUMINIO FORJADO, "COBRE"**  
**"COBRE" FORGED ALUMINIUM SAUCE POT**

Fondo inducción sistema "Full induction"

*Full induction base*

REF.	MEDIDA	COD. EAN	EMBALAJE
916-16	16 cm	8422309180207	6 ud



**ASADOR LISO ALUMINIO FORJADO**  
**FORGED ALUMINIUM GRIDDLE**

Fondo inducción sistema "Full induction"

*Full induction base*

REF.	MEDIDA	COD. EAN	EMBALAJE
518-36	36 cm	8422309070324	6 ud
518-47	47 cm	8422309070331	6 ud





**SARTÉN ALUMINIO FORJADO, "RED"**  
**"RED", FORGED ALUMINIUM FRYING PAN**

Full induction Quantanium

REF.	MEDIDA	COD. EAN	EMBALAJE
320-16	16 cm	8422309320108	6 ud
320-18	18 cm	8422309320115	6 ud
320-20	20 cm	8422309320122	6 ud
320-22	22 cm	8422309320139	6 ud
320-24	24 cm	8422309320146	6 ud
320-26	26 cm	8422309320153	6 ud
320-28	28 cm	8422309320160	6 ud
320-30	30 cm	8422309320177	6 ud



**SARTÉN HONDA FORJADA, "RED"**  
**"RED", FORGED ALUMINIUM DEEP-FRYING PAN**

Full Induction Quantanium

REF.	MEDIDA	COD. EAN	EMBALAJE
321-20	20 cm	8422309320184	6 ud
321-24	24 cm	8422309320191	4 ud
321-28	28 cm	8422309320207	4 ud
321-32*	32 cm	8422309320214	4 ud

\*Contiene asa auxiliar extra / includes an auxiliary handle



**CACEROLA "RED" FORJADA**  
**"RED", FORGED ALUMINIUM CASSEROLE**

Full Induction Quantanium

REF.	MEDIDA	COD. EAN	EMBALAJE
322-20	20 cm	8422309320306	4 ud
322-24	24 cm	8422309320313	4 ud
322-28	28 cm	8422309320221	4 ud
322-32	32 cm	8422309320238	4 ud



**ASADOR ONDULADO "RED" FORJADO**  
**"RED", FORGED ALUMINIUM GRILL PAN**

Full Induction Quantanium

REF.	MEDIDA	COD. EAN	EMBALAJE
323-27	28 cm	8422309320245	6 ud





**SARTÉN "RED" TAMAGOYAKI**  
**"RED", TAMAGOYAKI PAN**

Full Induction Quantanium

REF.	MEDIDA	COD. EAN	EMBALAJE
325-15	15 cm	8422309146432	10 ud



**OLLA "RED" FORJADA**  
**"RED", FORGED ALUMINIUM POT**

Full Induction Quantanium

REF.	MEDIDA	COD. EAN	EMBALAJE
326-24	24*11 cm	8422309146517	2 ud
326-28	28*12,5 cm	8422309146524	2 ud



**SARTÉN ALUMINIO FORJADO, "STONE"**  
**"STONE", FORGED ALUMINIUM FRYING PAN**

Fondo induction "Full induction", Mango tacto soft  
Full induction base, soft-touch handle

REF.	MEDIDA	COD. EAN	EMBALAJE
502-18	18 cm	8422309221115	6 ud
502-20	20 cm	8422309221122	6 ud
502-22	22 cm	8422309221139	6 ud
502-24	24 cm	8422309221146	6 ud
502-26	26 cm	8422309221153	6 ud
502-28	28 cm	8422309221160	6 ud
502-30	30 cm	8422309221177	6 ud



**CACEROLA ALUMINIO FORJADO, "STONE"**  
**"STONE", FORGED ALUMINIUM CASSEROLE**

Fondo induction "Full induction", Asas tacto soft  
Full induction base, soft-touch handles

REF.	MEDIDA	COD. EAN	EMBALAJE
505-24	24 cm	8422309001205	6 ud
505-28	28 cm	8422309231220	6 ud
505-32	32 cm	8422309231237	6 ud
505-34	34 cm	8422309332323	4 ud





**TAPA CRISTAL CON POMO INOXIDABLE, "STONE"**  
**"STONE", GLASS LID WITH STAINLESS STEEL KNOB**

REF.	MEDIDA	COD. EAN	EMBALAJE
506-24	24 cm	8422309001212	6 ud
506-28	28 cm	8422309231251	6 ud
506-32	32 cm	8422309231268	6 ud
506-34	34 cm	8422309332316	6 ud



**ASADOR LISO ALUMINIO FORJADO, "STONE"**  
**"STONE", FORGED ALUMINIUM GRILL PAN**

Fondo induction sistema "Full induction", Mango tacto soft  
*Full induction base, soft-touch handle*

REF.	MEDIDA	COD. EAN	EMBALAJE
507-27	27 cm	8422309231275	6 ud



**SARTÉN ALUMINIO FORJADO, "GREEN"**  
**ANTIADERENTE CERÁMICO ILAG**  
**"GREEN", FORGED ALUMINIUM FRYING PAN**  
**ILAG CERAMIC NON-STICK**

Fondo induction sistema "Full induction", Mango tacto soft  
*Full induction base, soft-touch handle*

REF.	MEDIDA	COD. EAN	EMBALAJE
508-18	18 cm	8422309231282	6 ud
508-20	20 cm	8422309231299	6 ud
508-22	22 cm	8422309231305	6 ud
508-24	24 cm	8422309231312	6 ud
508-26	26 cm	8422309231329	6 ud
508-28	28 cm	8422309231336	6 ud
508-30	30 cm	8422309231343	6 ud





**SARTÉN ALUMINIO FORJADO, "SUMMUM"**  
**"SUMMUM", FORGED ALUMINIUM FRYING PAN**

Fondo inducción sistema "Full induction" / Full induction base

REF.	MEDIDA	COD. EAN	EMBALAJE
AS16	16 cm	8422309124690	6 ud
AS18	18 cm	8422309124706	6 ud
AS20	20 cm	8422309124713	6 ud
AS22	22 cm	8422309124720	6 ud
AS24	24 cm	8422309124737	6 ud
AS26	26 cm	8422309124744	6 ud
AS28	28 cm	8422309124751	6 ud
AS30	30 cm	8422309124768	6 ud



**SARTÉN VOLTEA TORTILLA**  
**DOUBLE FRYING PAN FOR OMELETTES**

SARTÉN doble voltea-tortillas, inducción  
 Double omelette frying pan, induction

REF.	MEDIDA	COD. EAN	EMBALAJE
298	28 cm	8422309101400	4 ud
299	26 cm	8422309101295	4 ud
300	24 cm	8422309101271	4 ud
301	20 cm	8422309101288	6 ud



**SARTEN ALUMINIO, "GENNY"**  
**"GENNY", ALUMINIUM FRYING PAN**

Sartén 4.0 mm fondo inducción  
 4.0 mm full induction base

REF.	MEDIDA	COD. EAN	EMBALAJE
804-16	16 cm	8422309033244	6 ud
804-18	18 cm	8422309002882	6 ud
804-20	20 cm	8422309002899	6 ud
804-22	22 cm	8422309002905	6 ud
804-24	24 cm	8422309002912	6 ud
804-26	26 cm	8422309002929	6 ud
804-28	28 cm	8422309002943	6 ud
804-30	30 cm	8422309002936	6 ud





**SARTÉN HONDA ALUMINIO, "GENNY"  
"GENNY", DEEP ALUMINIUM FRYING PAN**

Fondo inducción, Sistema "Full induction", Mango Soft  
*Full induction base, soft-touch handle*

REF.	MEDIDA	COD. EAN	EMBALAJE
509-26	26 cm	8422309232142	6 ud
509-28	28 cm	8422309232135	6 ud
509-32*	32 cm	8422309232128	4 ud

\*Contiene asa auxiliar extra / includes an auxiliary handle



**SARTÉN "VULCANO" / "VULCANO" FRYING PAN**

SARTÉN aluminio 3.0 mm inducción  
*3.0 mm full induction base*

REF.	MEDIDA	COD. EAN	EMBALAJE
V16	16 cm	8422309182348	6 ud
V18	18 cm	8422309182355	6 ud
V20	20 cm	8422309182362	6 ud
V22	22 cm	8422309182379	6 ud
V24	24 cm	8422309182386	6 ud
V26	26 cm	8422309182393	6 ud
V28	28 cm	8422309182607	6 ud
V30	30 cm	8422309182508	6 ud



**SARTÉN FREIDORA CON CESTILLO  
FRYING PAN WITH BASKET**

SARTÉN FREIDORA aluminio 3.0 mm inducción  
*3.00 mm full induction base*

REF.	MEDIDA	COD. EAN	EMBALAJE
SF24	24 cm	8422309246033	6 ud
SF26	26 cm	8422309246040	6 ud





### SARTÉN 805 / 805 FRYING PAN

SARTÉN aluminio 2.0 mm inducción  
2.0 mm full induction base

REF.	MEDIDA	COD. EAN	EMBALAJE
805-16	16 cm	8422309002928	12 ud
805-18	18 cm	8422309003117	12 ud
805-20	20 cm	8422309003124	12 ud
805-22	22 cm	8422309003131	12 ud
805-24	24 cm	8422309003148	12 ud
805-26	26 cm	8422309003155	12 ud
805-28	28 cm	8422309003162	12 ud
805-30	30 cm	8422309003179	12 ud



### SARTÉN 803 ANTIHADERENTE CERÁMICO ILAG 803 FRYING PAN ILAG CERAMIC NON-STICK

SARTÉN aluminio 3.0 mm inducción  
3.0 mm full induction base

REF.	MEDIDA	COD. EAN	EMBALAJE
803-18	18 cm	8422309004015	6 ud
803-20	20 cm	8422309004022	6 ud
803-22	22 cm	8422309004039	6 ud
803-24	24 cm	8422309004046	6 ud
803-26	26 cm	8422309004053	6 ud
803-28	28 cm	8422309004060	6 ud
---	--	- - - - -	---



### 625/626

ASADOR redondo inducción 3.0 mm fondo pintado. No apto para Inducción

Roud griddle pan, 3.00 mm painted bottom. Not suitable for induction hobs

REF.	MEDIDA	COD. EAN	EMBALAJE
625	24 cm	8422309423014	6 ud
626	28 cm	8422309423021	6 ud





### 623/624 INDUCCIÓN / 623/624 INDUCTION

ASADOR cuadrado 3.0 mm fondo. Apto para inducción  
3.0 mm griddle pan. Suitable for induction

REF.	MEDIDA	COD. EAN	EMBALAJE
623	27*27cm Liso / Smooth	8422309423007	6 ud
624	27*27cm Ondulado / Wavy	8422309055550	6 ud



### 640

CAZO aluminio inducción 2.2 mm  
2.2 mm Induction aluminium sauce pot

REF.	MEDIDA	COD. EAN	EMBALAJE
640	12 cm	8422309112338	6 ud
641	14 cm	8422398111144	6 ud
642	16 cm	8422309111157	6 ud
643	18 cm	8422309111164	6 ud



### CAZO FREIDORA CON CESTILLO DEEP FRYER POT WITH BASKET

CAZO FREIDOR CON CESTA inducción 2.5 mm  
2.5 mm induction, Deep fryer pot with basket

REF.	MEDIDA	COD. EAN	EMBALAJE
SG16	16 cm	8422309246064	6 ud
SG18	18 cm	8422309246071	6 ud



### 500

OLLA aluminio con tapa, inducción 2.5 mm  
2.5 mm Induction aluminium pot with glass lid

REF.	MEDIDA	COD. EAN	EMBALAJE
500-18	18 cm	8422309101110	4 ud
500-20	20 cm	8422309101127	4 ud
500-22	22 cm	8422309101134	4 ud
500-24	24 cm	8422309101141	4 ud
500-26	26 cm	8422309101158	4 ud
500-28	28 cm	8422309101257	4 ud



**650**

POTE aluminio inducción 2.2 mm  
2.2 mm Induction aluminium milk pot

REF.	MEDIDA	COD. EAN	EMBALAJE
650	10 cm	8422309111171	6 ud
651	12 cm	8422309111188	6 ud
652	14 cm	8422309111195	6 ud

**700 I**

PAELLERA 4.0 mm aluminio inducción  
4.0 mm aluminium, paella pan

REF.	MEDIDA	COD. EAN	EMBALAJE
700-30 l	30 cm	8422309000697	6 ud
700-34 l	34 cm	8422309232326	6 ud
700-38 l	38 cm	8422309000895	6 ud
700-42 l	42 cm	8422309000918	6 ud
700-46 l	46 cm	8422309033251	6 ud

**GENNY 408**

PAELLERA 3.0 mm aluminio fondo esmaltado  
3.0 mm aluminium paella pan with enamelled base

REF.	MEDIDA	COD. EAN	EMBALAJE
408-30	30 cm	8422309122122	6 ud
408-34	34 cm	8422309122139	6 ud
408-38	38 cm	8422309122146	6 ud
408-42	42 cm	8422309122153	6 ud





# PINZAS





### Pinza pastelería premium

MEDIDAS (cm)	MATERIAL	REF.
18	INOX	031/1



### Pinza pastelería lujo

MEDIDAS (cm)	MATERIAL	REF.
18	INOX	31



### Pinza pastelería con aro

MEDIDAS (cm)	MATERIAL	REF.
16	INOX	660



### Pinza caracoles

MEDIDAS (cm)	MATERIAL	REF.
16	INOX	24



### Pinza ensalada

MEDIDAS (cm)	MATERIAL	REF.
22	INOX	469



Pinza spaghetti

MEDIDAS (cm)	MATERIAL	REF.
24	INOX	583



Pinza buffet

MEDIDAS (cm)	MATERIAL	REF.
24	INOX	468



Pinza con muelle reforzada corta

MEDIDAS (cm)	MATERIAL	REF.
16,5	INOX	037



Pinza hielo con muelle

MEDIDAS (cm)	MATERIAL	REF.
19	INOX	39



Pinza horno

MEDIDAS (cm)	MATERIAL	REF.
19	INOX	582



Pinza azúcar

<u>MEDIDAS (cm)</u>	<u>REF.</u>
18	20



Pinza azúcar mini

<u>MEDIDAS (cm)</u>	<u>MATERIAL</u>	<u>REF.</u>
8	INOX	69

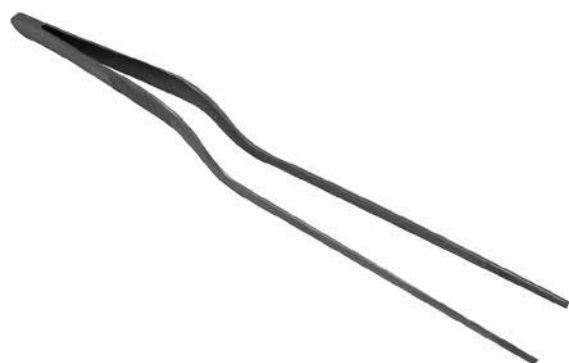

Pinza para sushi

<u>MEDIDAS (cm)</u>	<u>REF.</u>
22	66



Pinza para sushi

<u>MEDIDAS (cm)</u>	<u>REF.</u>
15	144



Pinza Barbacoa

<u>MEDIDAS (cm)</u>	<u>REF.</u>
57	402



Pinza charcutería

<u>MEDIDAS (cm)</u>	<u>MATERIAL</u>	<u>REF.</u>
10	INOX	656

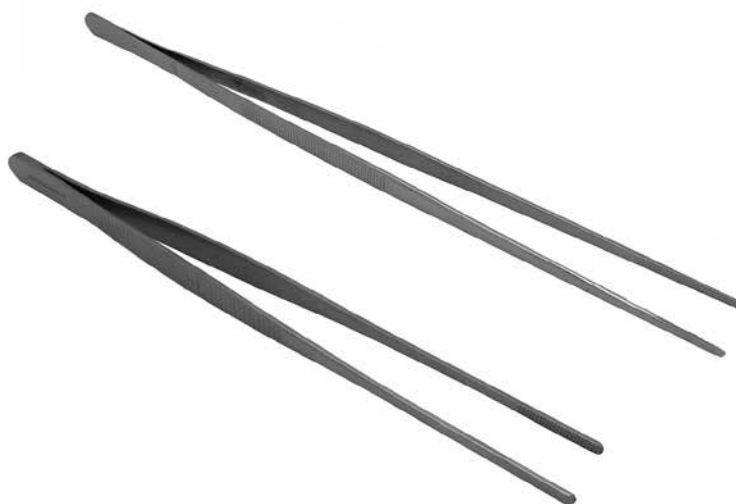

Pinza de precisión

<u>MEDIDAS (cm)</u>	<u>REF.</u>
31	82
21	83



Pinza mini para espigas

<u>MEDIDAS (cm)</u>	<u>REF.</u>
11	129

# Condiciones de venta

## Condiciones

Península: portes pagados a partir de 400€  
Baleares: portes pagados a partir de 500€  
Islas Canarias: portes pagados a partir de 1,200€

## Formas de pago

Recibo domiciliado.  
Pagaré.  
Cheque.  
Confirming.

 **HostelNovo**  
productos de hostelería